







 **Power**
Turns the detector On/Off.

 **Mode**
Toggles between Coin & Treasure Mode (🪙) and Prospecting Mode (🔍).
Activates Target ID Stabiliser.
Selects the automatic option for Ground Balance and Noise Cancel.

 **Patterns**
Scrolls through the different Discrimination Patterns.

 **All Metal**
Toggles between the selected discrimination pattern and the All Metal pattern.

 **Minus**
Adjusts settings, and scrolls to the left through the discrimination segments.

 **Menu**
Enters the Menu.
Accesses and scrolls through the detecting settings.

 **Pinpoint/Detect**
Pinpoint assists in locating the exact position of a target prior to recovery.
Detect exits menu settings and returns to detection.

 **Plus**
Adjusts settings, and scrolls to the right through the discrimination segments.

 **Accept/Reject**
Accepts or rejects discrimination segments.

 **Ground Balance**
Accesses the Ground Balance Menu.

 **Track**
Toggles between Ground Balance and Tracking Ground Balance.

 **Backlight**
Turns the Backlight On/Off.

Minelab Electronics Pty Ltd

Tel: +61 (0)8 8238 0888
Email: minelab@minelab.com.au



Minelab International Ltd

Tel: +353 (0)21 423 2352
Email: minelab@minelab.ie



Minelab MEA General Trading LLC

Tel: +971 4 254 9995
Email: minelab@minelab.ae



Minelab Americas Inc

Tel: +1 630 401 8150
Email: info@minelabamericas.com



2 How Detectors Work

2 VFLEX Technology

4 Assembling Your X-TERRA 705

4 List of Parts

5 Connecting the Coil

5 Shaft Assembly

6 Armrest Assembly

6 Connecting the Control Box

6 Disconnecting the Control Box

7 Coil Cable Assembly

7 Inserting Batteries

8 Keypad Layout

10 LCD Layout

12 Turning the Detector On

12 Detecting Modes

14 Holding the Detector

15 Sweeping the Coil

16 A Simple Detecting Exercise

17 Detector Audio

18 Coin & Treasure Mode**19 Prospecting Mode****20 Target ID**

20 Target ID Stability

21 Pattern Discrimination Scale

22 Preset Discrimination Patterns

24 Choosing a Discrimination Pattern

24 Pattern Discrimination

24 Iron Mask Discrimination

24 All Metal Shortcut

25 Editing Discrimination Patterns

26 Pinpointing

26 Pinpoint Auto

27 Pinpoint Sizing

28 Menu Operation

29 Adjusting Menu Settings

30 Sensitivity

31 Adjusting Sensitivity

32 Noise Cancel

33 Choosing a Noise Cancel Channel

34 Threshold

35 Adjusting Threshold

36 Volume

37 Adjusting Volume

38 Tones

38 Target Tones

38 Threshold Tone

39 Adjusting Tones

40 Ground Balance

40 Ground Balance (Normal)

40 Ground Balance (Beach)

42 Adjusting Ground Balance

44 Tracking Ground Balance Offset

45 Battery Behaviour**46 Factory Presets**

46 Mode Factory Preset

46 Erasing Patterns

48 Coil Identification

49 Error Messages

50 Sounds

51 Recovering the Target

52 Accessories

54 Care of your X-TERRA 705

55 X-TERRA 705 Specifications

56 Service Repair Form

Quick Start Reference Inside Front Cover

2 HOW DETECTORS WORK

Metal detectors create an electromagnetic field, which penetrates the ground. Metal objects cause a change to this field because they are conductive. The detector senses this change and sends a signal back to the control box, alerting the operator.

Metal detectors can determine the size, shape and composition of metallic objects beneath the coil. Typically, the larger the object, the easier it is to detect.

! *The frequency of a detector is the number of times a signal is transmitted into the ground, per second (measured in Hertz - Hz).
1000Hz = 1kHz.*

The X-TERRA 705 uses a single frequency (7.5kHz) as its standard operating frequency. This frequency has the ability to penetrate deep into the ground and is the most suitable for general purpose detecting.

The X-TERRA 705 is also capable of operating at frequencies of 3kHz and 18.75kHz, depending upon the selection of appropriate accessory coils (p. 48, 52).

The X-TERRA 705 has two main detecting modes: Coin & Treasure Mode (p.18) for general purpose detecting and Prospecting Mode (p. 19) for detecting gold nuggets and relics.

The specialised Prospecting Mode has improved Sensitivity and adjustable Iron Mask Discrimination. It is the ideal mode when searching for gold nuggets, small relics, and some types of jewellery.



The 2nd generation X-TERRA detectors continue to incorporate Minelab's proven VFLEX Technology.

VFLEX uses state of the art digital and mixed-signal components to enhance standard single frequency technology by replacing most of the analogue circuitry with digital signal processing. The small amount of analogue circuitry still employed has been very carefully designed and calibrated to obtain the outstanding sensitivity, stability and repeatability required to match the performance of the digital processing.

This radical departure from traditional approaches to metal detector design has been made possible by advances in electronics that power personal digital assistants, cell (mobile) phones and high-fidelity portable audio equipment.

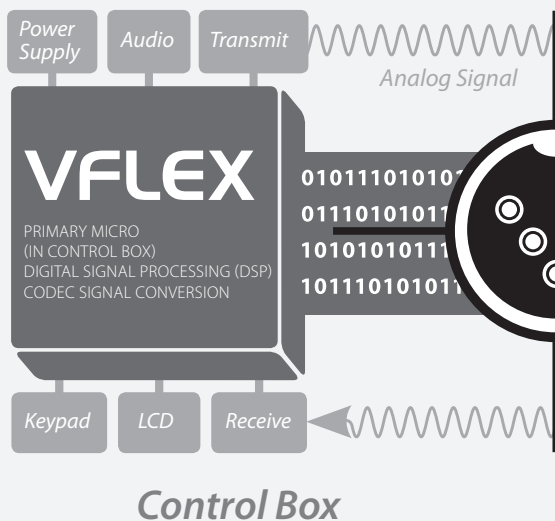

"BEEP!"



The X-TERRA 705 has two basic coil configurations, each with its own benefits.

A Concentric coil is the standard coil supplied with the X-TERRA 705 and is an all purpose coil with excellent pinpointing capabilities.

Double D coils are available also. They provide improved ground rejection and have a different detection profile.

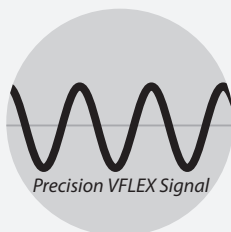
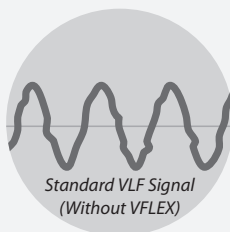
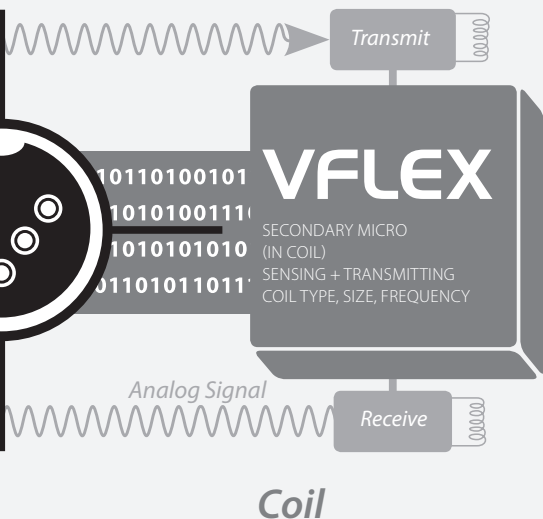

For the X-TERRA user, this precision means dependable performance and improved immunity to environmental conditions such as ground mineralisation, electromagnetic interference and temperature variations.

VFLEX requires coils that are accurately constructed and calibrated. Every time the detector starts up, the micro-controllers in the control box and the coil establish communication through a digital data link.

Information about the coil is sent to the control box, so the detector 'knows' what type of coil is attached and can set the appropriate operating parameters.

This optimises performance, and also makes the detector 'future proof'; in that it will be capable of operating at different frequencies depending on the electronic properties of the coil.

List of Parts

Before assembling your X-TERRA 705 please check that the package includes these parts:

- 1 Coil
- 2 Skidplate (fitted to coil)
- 3 Lower shaft
- 4 Middle shaft
- 5 Upper shaft
- 6 Armrest
- 7 Stand
- 8 Control box
- 9 Control box screw
- 10 Rubber washers (2)
- 11 Plastic wing nut
- 12 Plastic bolt
- 13 Armrest screw
- 14 Armrest strap
- 15 Velcro tabs (2)
- 16 Warranty card
- 17 Instruction manual you're holding it 😊

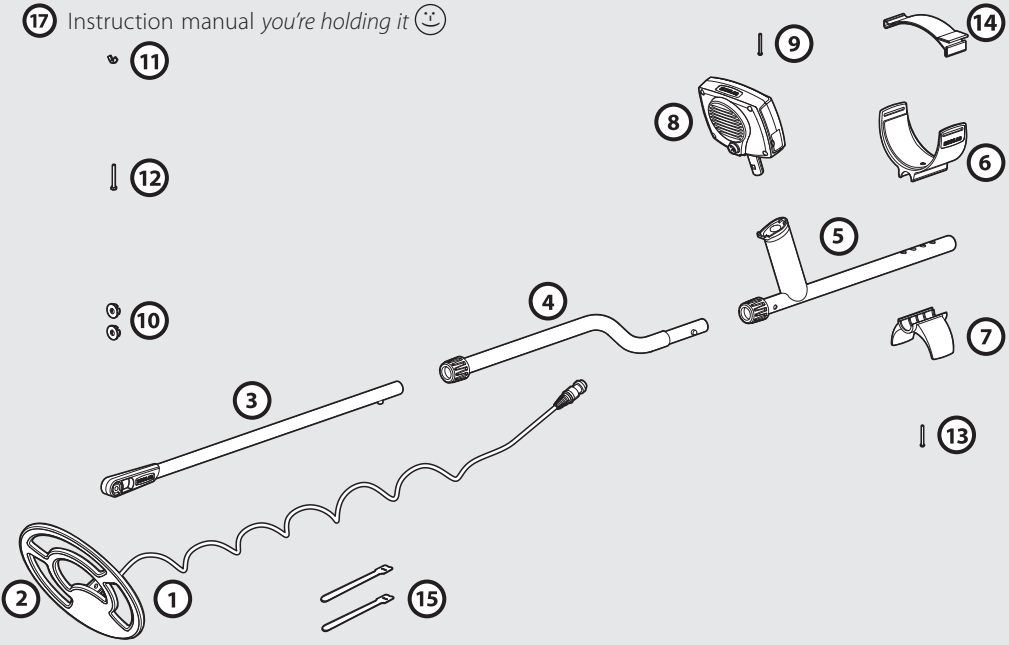
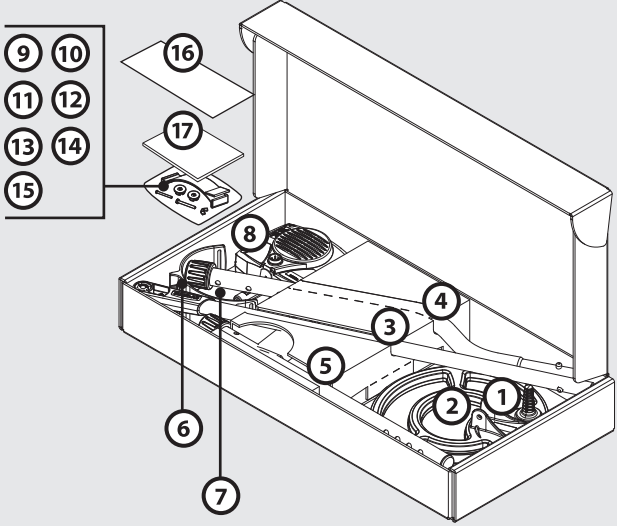

Connecting the Coil

- 1 Plug the two rubber washers into the holes on either side of the lower shaft yoke.
- 2 Slide the yoke into the yoke bracket on top of the coil. Ensure that the spring loaded pin in the lower shaft is pointing downwards.
- 3 Insert the plastic bolt through the yoke and the yoke bracket.
- 4 Fasten with the plastic wing nut provided, being careful not to damage the thread of the bolt by over-tightening. This may need to be loosened to adjust the coil to a comfortable detecting angle.

! *The coil cable is directly wired into the coil and is not removable. Any attempt to disconnect this cable will void your warranty.*

Shaft Assembly

- 1 Ensure that the twistlocks of the shafts are loosened by rotating them counter-clockwise.
- 2 Compress the spring loaded pin in the lower shaft and slide it into the middle shaft until the pin reaches the adjustment holes. The pin will spring out and click into place.
- 3 Attach the middle shaft to the upper shaft in the same way.
- 4 Once shafts are assembled, lock them in position by rotating twistlocks clockwise.

! *The upper shaft assembly location uses **two** spring loaded pins to strengthen the joint, one on each side of the shaft.*

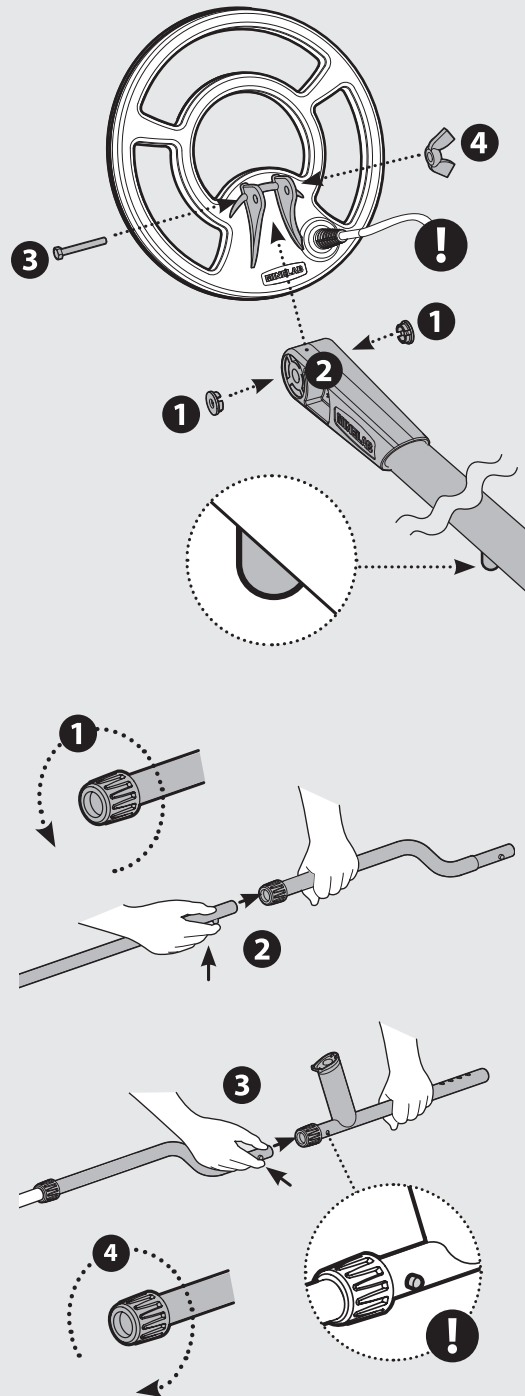

Armrest Assembly

- 1 Place the armrest onto the top of the upper shaft, lining up the central hole in the armrest with one of the holes in the aluminium shaft. Position the armrest to suit your arm length (*Holding the Detector, p. 14*).
- 2 Insert the screw up through the stand, upper shaft and armrest. Tighten the screw, being careful not to overtighten or damage the thread.
- 3 With the velcro side facing upwards, thread the armrest strap through both slots in the armrest. Ensure that the end of the strap will be fastened outwards from your arm.

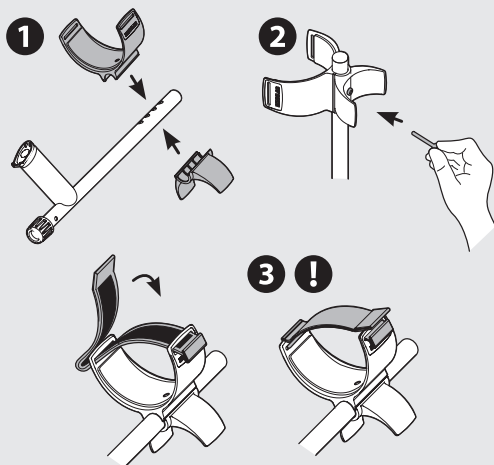

! The X-TERRA 705 is designed to be used in either the left or right hand. This diagram shows the velcro strap threaded outwards for the left arm.

Connecting the Control Box

- 1 With the LCD facing up, push the control box onto the end of the handle until it fits into place.

The control box may be easily removed for packing and transport.

Disconnecting the Control Box

Brace the detector firmly against yourself, grasp the control box and pull it away from the handle.

Permanently Connecting the Control Box

While the X-TERRA control box is designed to be easily removable for packing and transport, Minelab have made an option available to permanently attach the control box to the handle.

- 1 Remove the small circular rubber insert in the top right-hand side of the handle.
- 2 Insert the screw provided into the hole and tighten using a Phillips screwdriver.
- 3 Store the rubber insert in a safe place in case you wish to reuse it in the future.

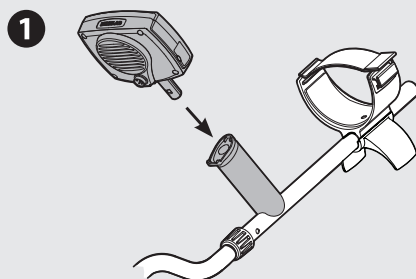

! Remember to remove this screw before attempting to disconnect the control box from the handle. Failure to do this may result in damage occurring.

! If this option is not used, then the rubber insert may be glued in place using a silicone sealant or other suitable adhesive.

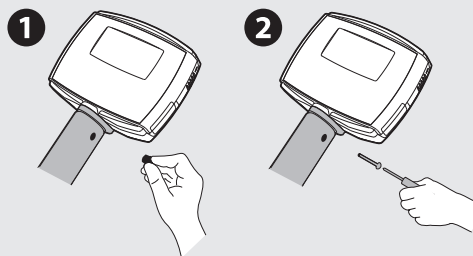

Coil Cable Assembly

- 1 Wind the coil cable around the lower and middle shaft enough times to take up the slack.
- 2 Use the velcro tabs to keep the coil cable in place against the shaft. It is recommended that one tab is used on the lower shaft close to the coil and the other tab on the middle shaft before the cable reaches across to the control box.
- 3 Align the coil plug and push it into the socket in the back of the control box, firmly tightening the retaining ring to hold it in place.

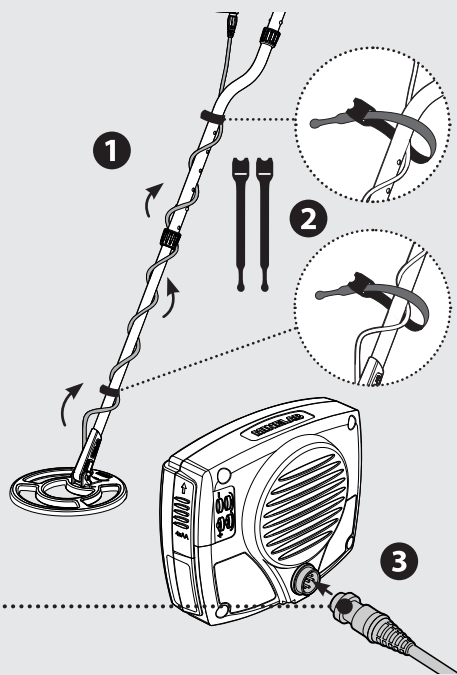

Inserting Batteries

The X-TERRA 705 uses 4 x AA batteries which are not included with the detector
(*Battery Behaviour*, p. 45).

- 1 Access the battery compartment via the battery door located on the side of the control box. Slide the battery compartment door upwards with your thumb.
- 2 Place individual batteries into the compartment as illustrated, ensuring the positive (+) and negative (-) contacts match the diagram on the control box.
- 3 Close the battery door by pushing and sliding it downwards.

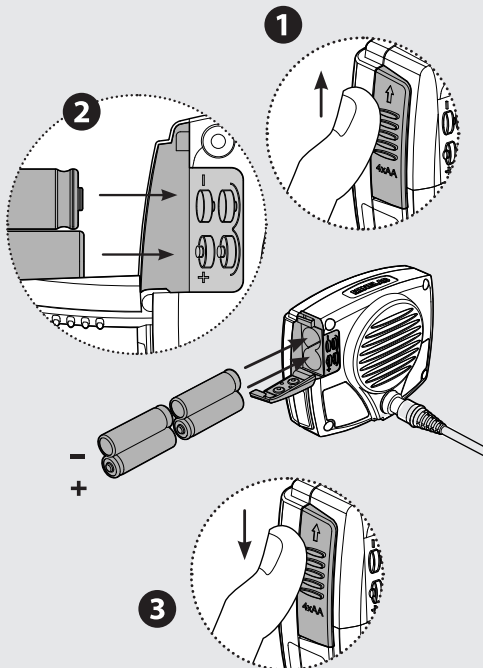

! If the detector does not turn on correctly, check the battery orientation. The detector will not be damaged if the batteries are inserted incorrectly.

Power
Turns the detector On/Off.

Patterns
Scrolls through the different Discrimination Patterns (Coin & Treasure Mode only).

Mode
This button has three functions.
Toggles between **Coin & Treasure Mode** (🇺🇸) and **Prospecting Mode** (⚡).
Activates **Target ID Stabiliser**.
Selects the automatic option for **Ground Balance** and **Noise Cancel**.

All Metal
Toggles between the selected discrimination pattern and the All Metal pattern.

Minus
Adjusts settings, reduces Iron Mask and scrolls to the left through the discrimination segments.

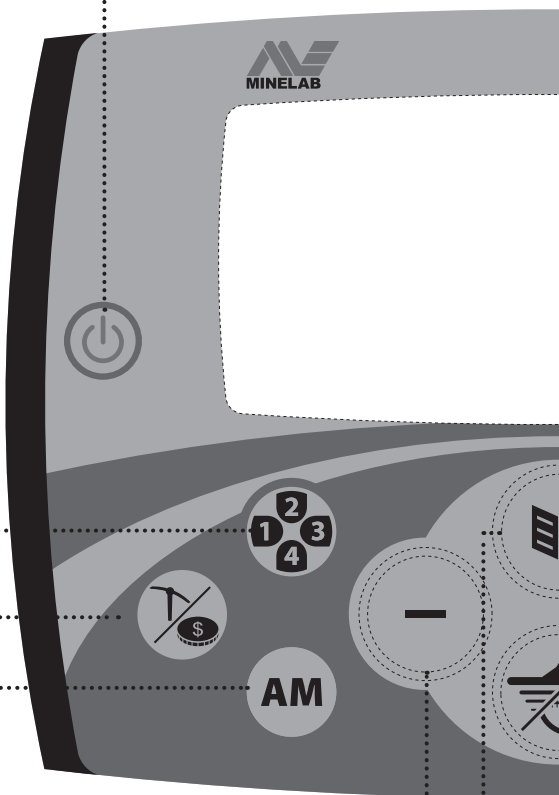

Menu/Select
Enters the Menu.
Accesses and scrolls through the detecting settings.

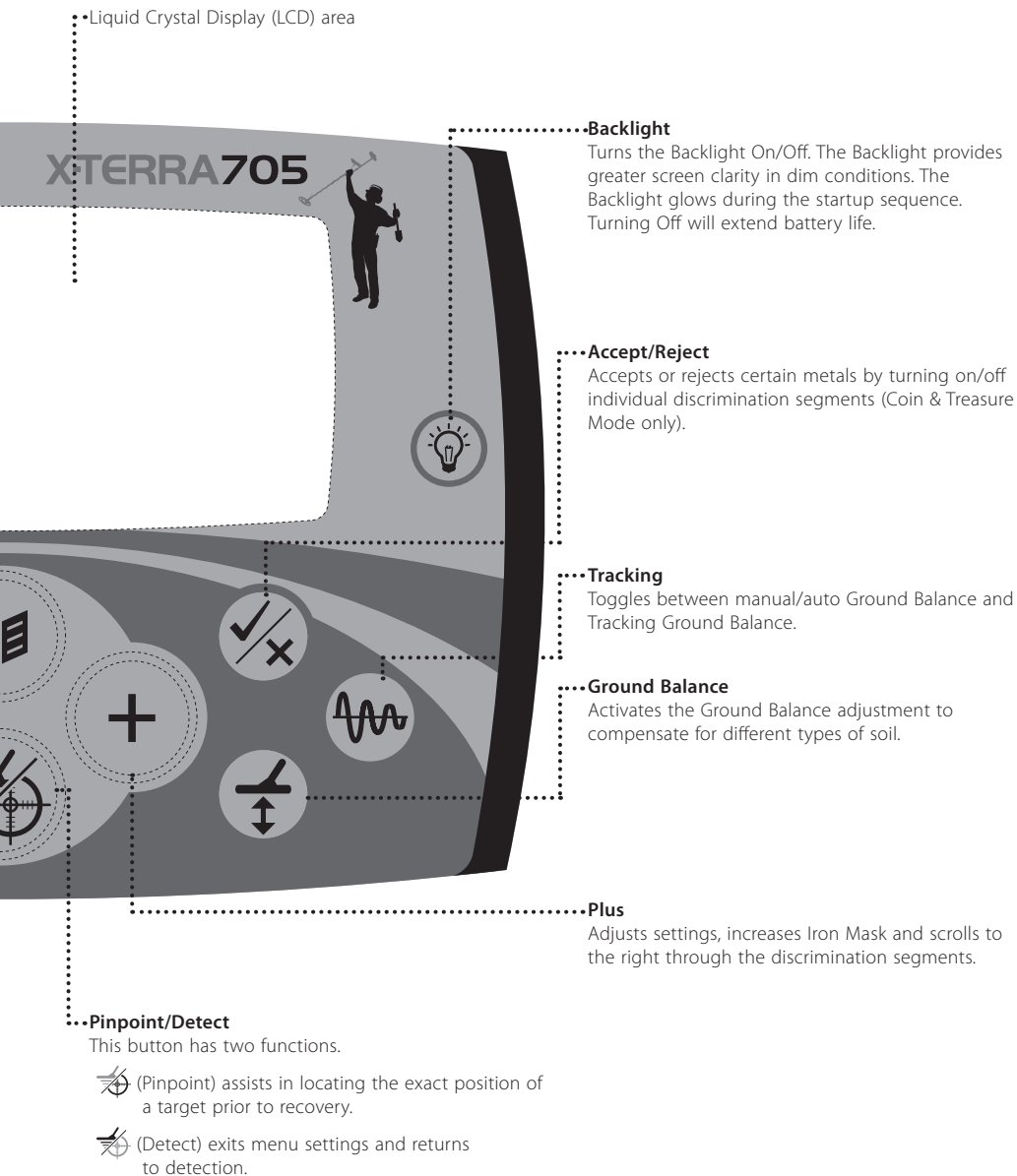

! *Headphones are not included with the X-TERRA 705 (Accessories, p. 52).*

Target ID Stability
This icon indicates that Target ID Stability has been selected (*Target ID Stability, p. 20*).

Headphones
This icon indicates that headphones are connected and that the Headphone Volume and Threshold have been selected (*Volume, p. 36*).

Backlight
This icon indicates when the Backlight is On.

Battery
This icon indicates how much power is left in the batteries (*Battery Behaviour, p. 45*).

All Metal (AM)
Indicates that the All Metal Pattern has been selected. This pattern has no discrimination and will allow signals from all types of metals, both ferrous and nonferrous (*Preset Discrimination Patterns, p. 22*).

Patterns
Preset Discrimination Patterns are used to suit different search preferences (Coin & Treasure Mode only).
The X-TERRA 705 has four patterns. (*Preset Discrimination Patterns, p. 22*).

Iron Mask (IM)
Indicates that the Iron Mask discrimination has been selected (Prospecting Mode only) (*Preset Discrimination Patterns, p. 22*).

Target ID
Target ID numbers range from -8 to 48. Negative numbers indicate ferrous targets and positive numbers indicate nonferrous targets (Coin & Treasure Mode).
These numbers also have other functions. They are used when adjusting menu settings and for displaying the Iron Mask value (*Target ID, p. 20*).

Discrimination Scale
Used for Pattern Discrimination (Coin & Treasure Mode only) and Iron Mask Discrimination (Prospecting Mode only) (*Pattern Discrimination Scale, p. 21*).

Reject Identification
🗑️ appears when rejecting a discrimination segment. It disappears when accepting a discrimination segment (*Editing Discrimination Patterns, p. 25*).

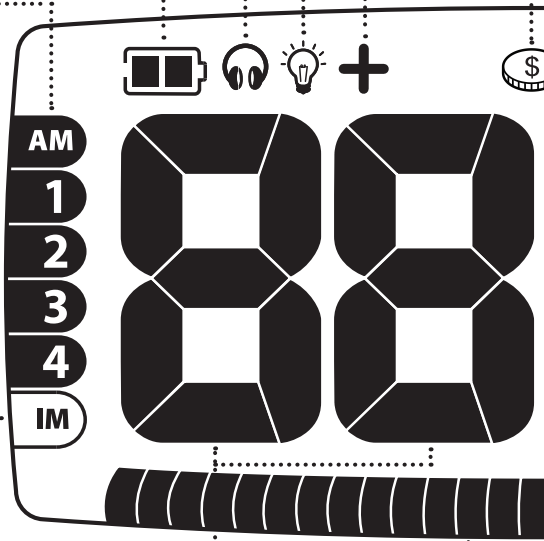

Coin & Treasure Mode

This icon indicates that the Coin & Treasure Mode has been selected (*Coin & Treasure Mode, p. 18*).

Prospecting Mode

This icon indicates that the Prospecting Mode has been selected (*Prospecting Mode, p. 19*).

Tracking

This icon indicates that Tracking Ground Balance has been selected (*Adjusting Ground Balance, p. 42*).

Beach

This icon indicates that Ground Balance (Beach) has been selected (*Ground Balance (Beach), p. 40*).

Depth Indicator

The depth indicator is a relative guide to how deep a target is. The more arrows displayed, the deeper the target is likely to be (Coin & Treasure Mode only).

1 arrow is approximately 0–2" (0–5 cm).

Targets at depths greater than 10" (25 cm) will display 5 arrows.



Actual depth will be more accurate for coins than junk ferrous targets.



Shallow target

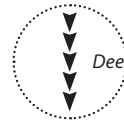

Deep target

Pinpoint

Indicates that Pinpoint has been activated (*Pinpointing, p. 26*).

Menu Scale

Consists of 10 segments within a circular scale line.

This works in conjunction with the Numeric ID to show the value of the selected setting adjustment.

The Menu Scale also works with Pinpoint to indicate how close the coil is to the target

(*Menu Operation, p. 28*).

Menu

A list of settings (Sensitivity, Noise Cancel, Threshold, Volume and Tones) that can be adjusted to customise personal preferences (*Menu Operation, p. 28*).



Ground Balance can only be accessed via the **Ground Balance** button.

(*Ground Balance, p. 40*)

It is recommended to only turn the detector on, when outdoors, away from sources of electromagnetic disturbance.

There are many metallic objects inside a house (e.g. nails in the floor, reinforcing in the walls) that might overload the electronics of the detector.

There may also be interference from TV sets and other household appliances. In this environment the detector may perform erratically, giving numerous false signals.

If the detector emits an overload sound and displays **OL** on the LCD move the coil away from the source of the overload (*Error Messages, p. 49*).

! *Overloading is not harmful to the electronics of the detector.*

Detecting Modes

Before detecting, it is important to understand that the X-TERRA 705 can operate in two different detecting modes, *Coin & Treasure Mode, p. 18* and *Prospecting Mode, p. 19*.



 *The Coin & Treasure Mode and Prospecting Mode symbols will appear throughout the rest of this manual to indicate functions specific to each mode only.*





1 Press **Power**

A short start-up sequence will display and a tune will be heard.

Once on, the detector will be in the factory default Coin & Treasure Mode. There will be no numeric reading until a metal object is detected.

Coin & Treasure Mode Factory Presets	
<i>Discrimination Pattern</i> 	1
<i>Sensitivity</i>	16
<i>Ground Balance</i>	(Fixed) 27
<i>Noise Cancel Channel</i>	0
<i>Threshold (Speaker)</i>	12
<i>Threshold (Headphones)</i>	10
<i>Volume (Speaker)</i>	25
<i>Volume (Headphones)</i>	20
<i>Target Tones</i> 	4

1 Press **Mode** to toggle between Coin & Treasure Mode and Prospecting Mode.

Prospecting Mode Factory Presets	
<i>Iron Mask</i> 	5
<i>Sensitivity</i>	22
<i>Ground Balance</i>	(Track)
<i>Noise Cancel Channel</i>	0
<i>Threshold (Speaker)</i>	10
<i>Threshold (Headphones)</i>	8
<i>Volume (Speaker)</i>	25
<i>Volume (Headphones)</i>	20
<i>Threshold Tone</i> 	22

! This illustration is a representation of the LCD layout showing some of the icons that appear during startup. Please note that not all LCD icons are displayed at the same time.

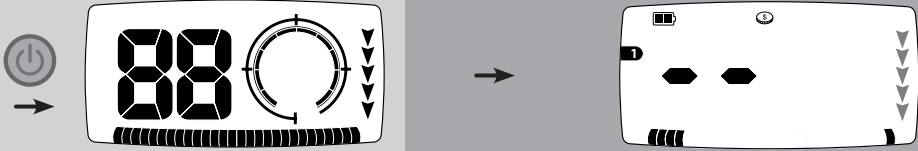

! The X-TERRA 705 can save separate settings for each mode. When the Detecting Mode is changed, the menu settings that have changed will flash for three seconds.

For example, if Sensitivity is 16 in Coin & Treasure Mode and 22 in Prospecting Mode the Sensitivity icon will flash for three seconds when switching Detecting Mode.

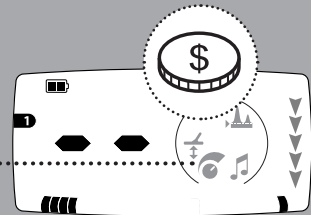

! Many of the screen diagrams in this manual, that refer to features and settings common to both modes, show the Coin & Treasure Mode display only.

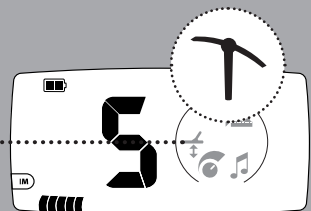

14 HOLDING THE DETECTOR

To hold the detector, thread your arm through the armrest and strap. Grasp the handle of the detector and rest your forearm in the armrest.

Your elbow should sit just above the top of the armrest. Lightly tighten the velcro strap and secure it around your arm.

The correct position of armrest and length of shaft should allow you to swing the coil in front of your body without any uncomfortable stretching or stooping.

To adjust the length of the shafts, undo the twistlocks, compress the spring pins of the shafts and move them up or down to suit.

Once all shafts have been clipped into position, rotate twistlocks clockwise onto the shafts until they are firmly clamped (*Shaft Assembly, p. 5*).

To adjust the position of the armrest remove the armrest screw and move the armrest and stand to the desired position (*Armrest Assembly, p. 6*).

! *Think of the detector as an extension of your arm. It should be straight with your forearm and feel light and comfortable when you pick it up.*

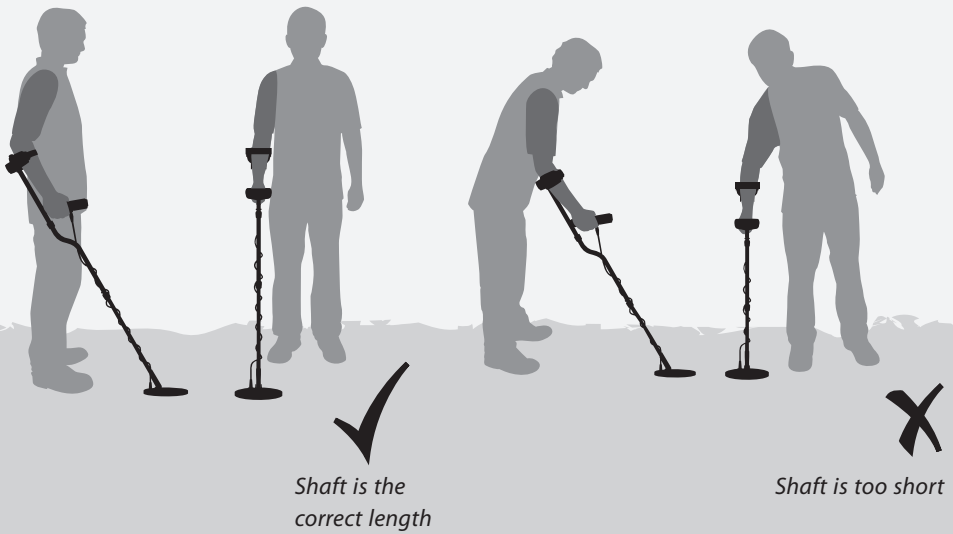

Once outside, practise sweeping the coil over the ground in a side-to-side motion, while walking forward slowly. Slightly overlap the previous sweep to ensure full ground coverage. An average sweep speed is three seconds from left to right to left.

! *Try sweeping the coil faster in Coin & Treasure Mode for improved target detection and identification.*

Try sweeping the coil slower in Prospecting Mode for improved target detection and separation from ground mineralisation signals.

It is important to keep the coil close and parallel to the ground at all times. This will increase detection depth and response to small objects. Avoid excessive brushing of the coil on the ground, as this may result in false signals and inaccurate Target ID's.

A variation in coil height at the end of each swing may also cause confusing sounds and reduce detection depth.

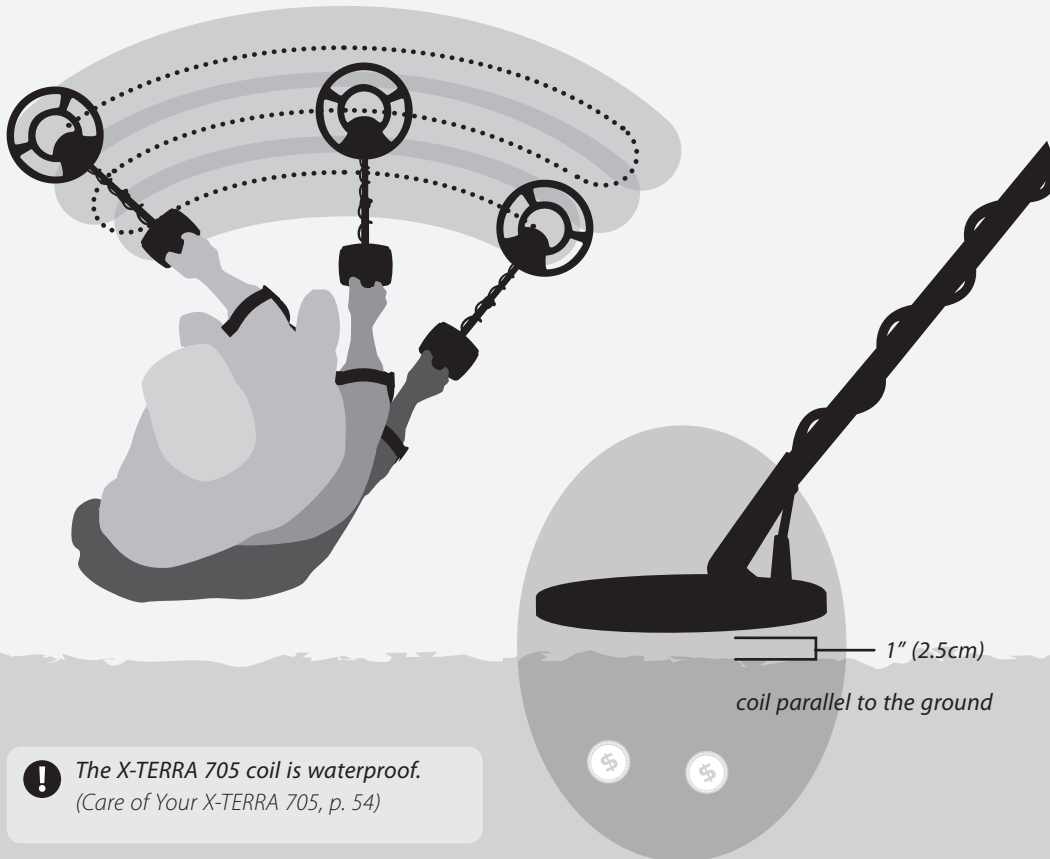

! *The X-TERRA 705 coil is waterproof.*
(Care of Your X-TERRA 705, p. 54)

Buried metal objects are referred to as targets. Before attempting to pinpoint or recover real targets, it is important to understand how to interpret the audio and visual signals of the detector.

A good way to become familiar with detecting is to test the detector with a range of metal objects. This exercise is a simple lesson on how the detector interprets metal objects.

Gather a collection of different metal objects, e.g. various coins, gold and silver jewellery, a nail, pull-tab, brass button and aluminium foil.

Take the detector outdoors, away from known electromagnetic fields or metal objects.

Lay objects in a line, sufficiently spaced apart to allow the coil to pass between the objects.

Pass the coil across the objects one at a time, and observe the LCD and the sounds of the detector as it detects each object.

Don't worry if the detector is not producing a sound over the nail — this is because the detector begins in the default Pattern 1, a setting which rejects signals from common junk targets, including ferrous targets.

Note: *If you are getting signals from a clear patch of ground, there could be buried metal objects. Try finding another area.*

If the detector is making popping and crackling sounds, and displaying numbers when the coil is not over one of the metal objects, try reducing its Sensitivity (p. 30). Once stable, the detector will sound and display numbers only when the coil is passed over a target.

! *This test exercise may be used when adjusting the settings of the detector (Sensitivity, p. 30; Threshold, p. 34; Volume, p. 36; Tones, p. 38).*



Nail



Pull-Tab



Foil



Coins



Jewellery

Target Response (Metal Object Response)

This is the sound given by the detector when a target is located and not discriminated (rejected).

 In Coin & Treasure Mode a highly conductive target (e.g. a large silver coin) will generally cause a high pitched beep and a ferrous target will generally cause a low pitched beep.

 In Prospecting Mode, a target will cause an abrupt change in pitch and volume of the Threshold tone. Detections are indicated by sound only.

(Tones, p. 38)

(Sounds, p. 50)

False Signals

The detector may also produce False Signals (Noise) when not over the ground or with the coil held motionless. These may not be target signals, but surrounding electromagnetic interference (EMI). The Ground Balance and Noise Cancel settings can be used to overcome these false signals.

(Noise Cancel, p. 32)

(Ground Balance, p. 40)

Threshold (Background sound)

This is the background 'buzz' produced by the detector, used to help distinguish between desired and undesired objects.

Blanking

When a rejected target is detected the Threshold sound 'blanks' (becomes silent), indicating that a target is located underneath the coil but has been rejected by your discrimination pattern. Blanking is a useful way of distinguishing between desired and undesired targets.

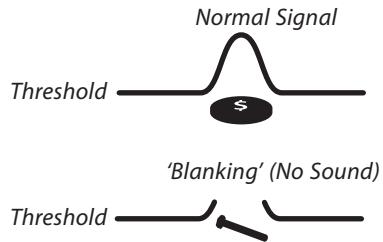

Highly mineralised soil may produce false signals and distract from real targets.





Coin & Treasure Mode is used for detecting valuable objects including old and modern coins, jewellery and artefacts. Undesired objects such as pull-tabs and bottle caps may be rejected. This mode can be used in a variety of environments such as parks and salt water beaches.

The numerals (Target ID) and the segmented scale (Pattern Discrimination Scale) are used to identify particular metal objects in the ground.

Target ID

Metal objects are called targets. The Target ID is the numeric indication of a particular metal object.



A metal object in Coin & Treasure Mode is identified by a single 'beep' tone (Target Tones, p. 38).

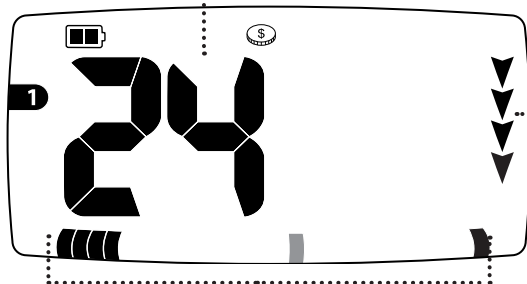

Pattern Discrimination Scale

Every detected target is represented as a segment on the Pattern Discrimination Scale. By turning individual segments on/off, you are rejecting or accepting target signals. A flashing icon indicates a particular metal detection.

Depth

The depth arrows indicate the relative depth of a target from the coil.



The depth arrows only operate in Coin & Treasure Mode.

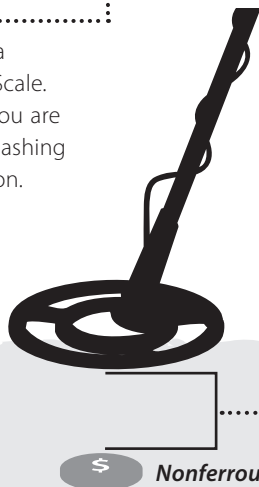

Nonferrous coin



Prospecting Mode is used to find metal such as gold nuggets and relics in highly mineralised, 'difficult' areas.

Targets are identified by audio only. The number on the display is not related to the target; instead, it shows the Iron Mask value, as does the Discrimination Scale. In this mode the detector becomes more sensitive to small target signals.

The numerals (Iron Mask Level) and the segmented scale (Iron Mask Discrimination Scale) are used to identify the amount of iron signals being rejected by the detector.



A metal object in Prospecting Mode is identified by an abrupt change in pitch and volume of the Threshold tone (Threshold Tone, p. 38).

Iron Mask (IM) Level

The numeric indication of the Iron Mask Level (not as the identifier of particular targets as it is in Coin & Treasure Mode).

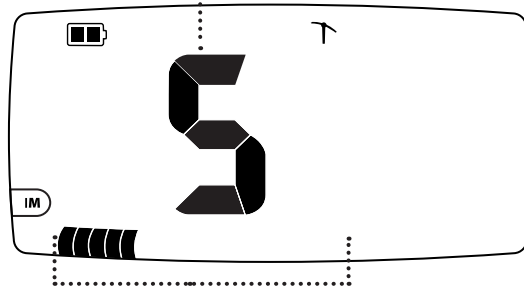

Iron Mask Discrimination Scale

The visual indication of the Iron Mask Discrimination Scale. By increasing the Iron Mask Level you are rejecting more iron signals. The Iron Mask range is 0-20 and uses only the first 20 segments of the Discrimination Scale.



When using Prospecting Mode, Double D coils will often improve performance and ground balancing in heavily mineralised areas.



Gold nuggets



Buried metal objects are referred to as **targets**. Target signals contain ferrous and conductivity information.

As the coil is passed over a target, the detector digitally processes the target signal and displays this as a number. Target Identification (ID) is used to distinguish one type of metal target from another.

Target ID numbers range from -8 to 48. Negative numbers represent ferrous targets and positive numbers represent nonferrous targets.



The last detected Target ID stays on the display until another target is detected. If the detector passes over a target that it rejects, the display will show two dashes instead of a number.

Target ID Stability

The X-TERRA 705 has a fine Discrimination Scale, but this may result in some instability of the displayed Target ID in some areas with highly mineralised soil.

In these cases, the Target ID numbers may be further stabilised by using the Target ID Stabiliser. The Target Tone may not always match the stabilised Target ID.

Activating Target ID Stability

- 1 In the detection screen, press and hold **Mode**  for three seconds. The **+** icon will appear, indicating that Target ID Stability is activated.
- 2 To de-activate Target ID Stability, press and hold **Mode**  for three seconds. The **+** icon will disappear, indicating that Target ID Stability is de-activated.

Target ID

The numeric identifier of a particular metal object underneath the ground.

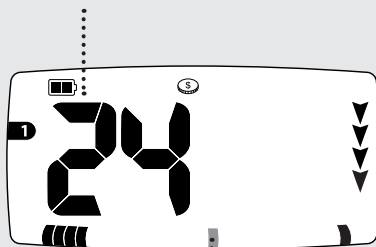

Discrimination segment

Each segment refers to a certain type of metal signal. Segments can be turned off (to accept targets) or turned on (to reject targets), accepting or rejecting signals from the corresponding metal objects.



A grey icon on the diagrams in this manual represents a flashing icon on the detector.



Press and hold to activate/de-activate Target ID Stability.



Many of the screen diagrams in this manual refer to the X-TERRA 705 operating in the default Coin & Treasure Mode.



In addition to the Target ID, targets are also represented as a particular segment on a linear scale at the bottom of the display.

Each discrimination segment represents a level of conductivity and ferrous content.

Nonferrous targets are those that have no iron content, such as gold, silver, copper and bronze. Nonferrous targets are often higher in conductivity and are represented by the right-hand side segments.

Ferrous targets are those that contain iron (e.g. nails). They are generally magnetic and are represented by the left-hand side segments.

Desired and undesired targets may appear anywhere along the discrimination scale, e.g.

Desired ferrous target - Canadian coin

Undesired ferrous target - iron nail

Desired nonferrous target - gold coin

Undesired nonferrous target - pull-tab

Discrimination segments may be turned on or off, rejecting or accepting certain targets, respectively (*Editing Discrimination Patterns*, p. 25).

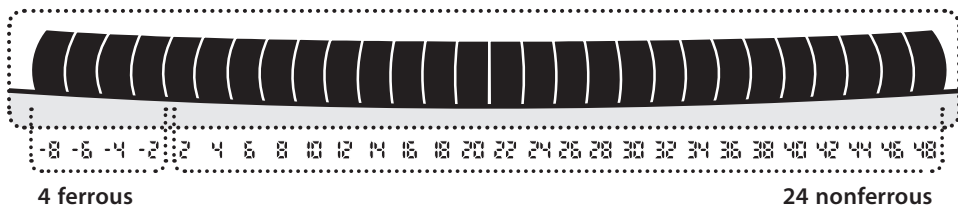

The X-TERRA 705 has 28 ID segments. The target IDs range from -8 to 48, increasing in steps of 2.

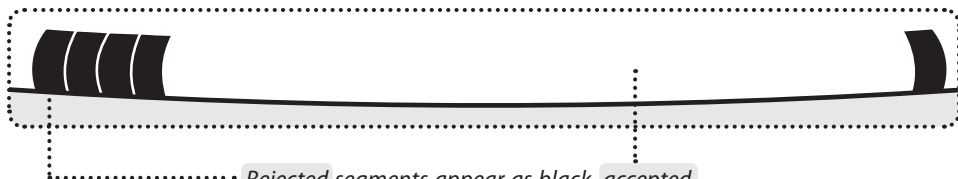

Rejected segments appear as black, accepted segments disappear altogether (allowing signals from metal objects). The combinations of accepted and rejected segments are called Discrimination Patterns.

The X-TERRA 705 has an All Metal Pattern, four preset Discrimination Patterns and Iron Mask.

 The combinations of accepted and rejected segments are referred to as Discrimination Patterns. The X-TERRA 705 has preset Discrimination Patterns that have been customised to detect general desired targets, such as coins and jewellery.

Patterns 1, 2, 3 and 4 can be edited by you to create your own custom Discrimination Patterns. Edited patterns are automatically saved when switching patterns and when the detector is turned off.

(Editing Discrimination Patterns, p. 25)

(Erasing Patterns, p. 46)

 In Prospecting Mode, the objective is to find targets in mineralised, 'difficult' ground where target signals overlap each other.

The Discrimination Scale becomes an expanded Ferrous Discrimination Scale (Iron Mask Discrimination Scale).

If the Iron Mask setting is adjusted towards 0 most gold nuggets will be accepted, but some ferrous junk may also be accepted.

If the Iron Mask setting is adjusted towards 20, more ferrous junk will be rejected but some gold nuggets may also be rejected.

 ***It is recommended that Iron Mask levels be kept low to avoid missing valuable targets.***



All Metal Pattern

Accepts signals from all types of metals, everything from jewellery to rusty nails (*all target IDs*). No target signals are rejected.



Pattern 1

Accepts signals from nonferrous targets, e.g. gold jewellery and silver coins (*target IDs: 2, 4, 6, 8, 10, 12, 14, 16, 18, 20, 22, 24, 26, 28, 30, 32, 34, 36, 38, 40, 42, 44, 46*). Rejects ferrous objects and hot rocks (*target IDs: -8, -6, -4, -2, 48*).



Pattern 2

Accepts signals from nonferrous targets (*target IDs 8, 10, 12, 28, 30, 32, 34, 36, 38, 40, 42, 44, 46*). Rejects those from ferrous objects, hot rocks and some nonferrous targets, e.g. aluminium foil and pull tabs (*target IDs -8, -6, -4, -2, 2, 4, 6, 14, 16, 18, 20, 22, 24, 26, 48*).



Pattern 3

Accepts signals from some ferrous (relics) and most nonferrous targets (*target IDs -6, -4, 6, 8, 10, 12, 14, 16, 18, 20, 22, 24, 26, 28, 30, 32, 34, 36, 38, 40, 42, 44, 46*). Rejects those from ferrous objects, hot rocks and some nonferrous targets, e.g. aluminium foil (*target IDs -8, -2, 2, 4, 48*).



Pattern 4

Accepts signals from some ferrous and most nonferrous targets, e.g. gold jewellery and silver coins (*target IDs: -2, 2, 4, 6, 8, 10, 12, 14, 16, 18, 20, 22, 24, 26, 28, 30, 32, 34, 36, 38, 40, 42, 44, 46*). Rejects most ferrous objects and hot rocks (*target IDs: -8, -6, -4, 48*).



Iron Mask

Accepts or rejects signals from ferrous and nonferrous targets, e.g. gold nuggets.

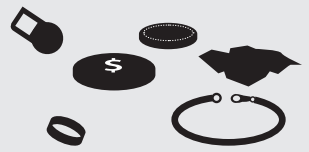
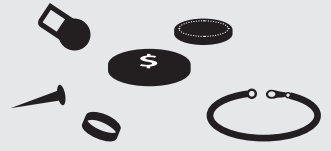
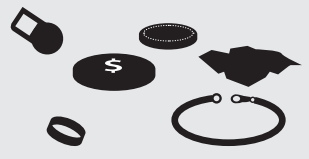
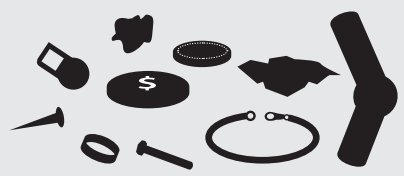

Example targets only

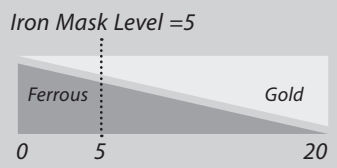
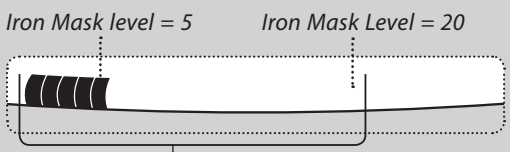

The Iron Mask only uses 20 segments of the Discrimination scale.

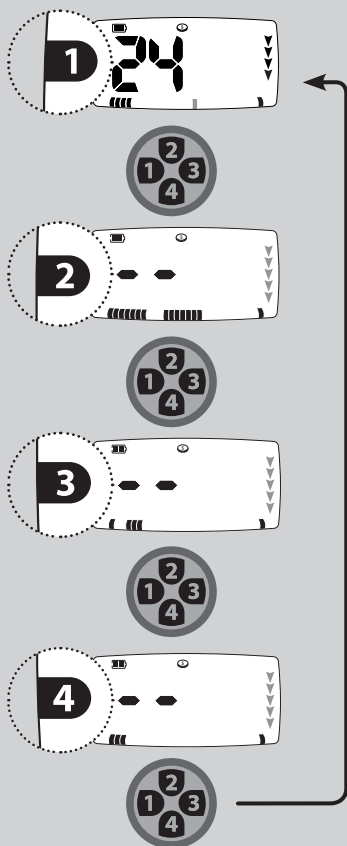

Pattern Discrimination

In Coin & Treasure Mode use **Patterns**  to toggle between Pattern 1, Pattern 2, Pattern 3 and Pattern 4.





All Metal Shortcut

The X-TERRA 705 has an All Metal shortcut available in both modes.

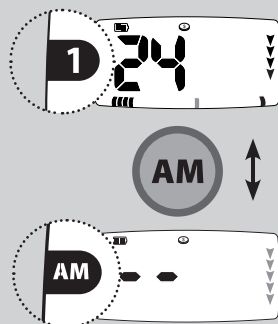
 In Coin & Treasure Mode, press **All Metal**  to toggle between the selected Pattern and All Metal.



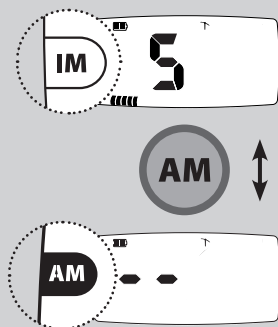

 In Prospecting Mode, press **All Metal**  to toggle between Iron Mask and All Metal.

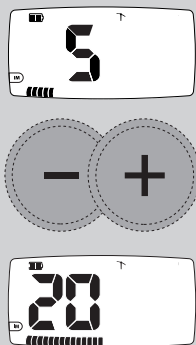

Iron Mask Discrimination

In Prospecting Mode use + and - to adjust the Iron Mask Discrimination scale.



 When the Iron Mask Level is set to 0, the detector behaves the same as in All Metal Pattern.

 The All Metal Pattern cannot be edited.

The Preset Discrimination Patterns may be edited to create custom patterns.

Method 1 – to reject a specific Target ID using an actual target

When a target is detected a discrimination segment will flash, indicating its position on the discrimination scale, and the target's ID number will appear on the LCD.



Press **Accept/Reject**  to reject that Target ID.

The discrimination segment and  icon will appear to indicate that the detected ID is now rejected.

Check that the Target ID has been rejected by detecting again. There should be no audio response (blanking) from that target (*Detector Audio, p. 17*).

Method 2 – to reject a specific Target ID using + or -

Use **+** and **-** to scroll through and select the Target ID you want to modify. The flashing segment and the Target ID number will indicate the selected ID.

Press **Accept/Reject**  to either accept or reject that ID. The discriminated segment and the  icon will appear if rejected. The segment and the  icon will disappear if accepted.

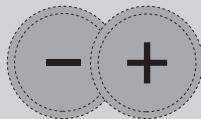
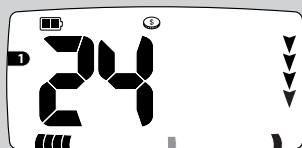

 **Accept/Reject toggles between accepting and rejecting targets.**

When a signal is heard, it is an advantage to identify the exact position of the target.

This is best determined by using **Pinpoint** .

Enabling Pinpoint instructs the X-TERRA 705 to temporarily disengage discrimination and become a non-motion detector.

In Pinpoint, the detectors response indicates the strength of the target signal directly below the coil. The Pinpoint audio response is tone and volume modulated. The difference in tone and volume produced will help locate the position and depth of the target.

The X-TERRA 705 is programmed with two Pinpoint Modes; Pinpoint Auto (default) and Pinpoint Sizing.

Pinpoint Auto

Pinpoint Auto progressively masks the Target response by reducing the Sensitivity with each sweep until only a very narrow target response remains. This helps identify the exact location of the target.

- 1 Once the approximate target location is known, move the coil away from that area and press **Pinpoint** .
- 2 Sweep the coil slowly over the target location. The menu scale segments on the LCD indicate how close the target is to the centre of the coil. The detector will produce the highest volume and tone when the centre-ring of the concentric coil is directly above the target.
- 3 Taking note of the response, reduce the span of each successive pass of the coil until you are confident of the location of the target. Make a mental note of the position or, mark a line with your shoe or a digging tool.
- 4 Move to one side so that you can pass the coil over the target at right angles to your initial direction. When the detector sounds you should know exactly where to dig.

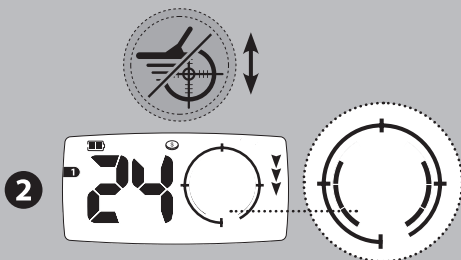
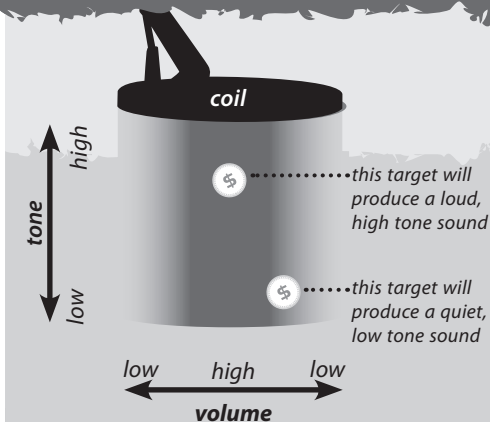

! If you have difficulty Pinpointing the target, press **Pinpoint/Detect** again to take the detector out of Pinpoint and then return to Step 1.

! The detector may become noisy if left in Pinpoint. If this occurs, return to normal detection then try Pinpoint again.

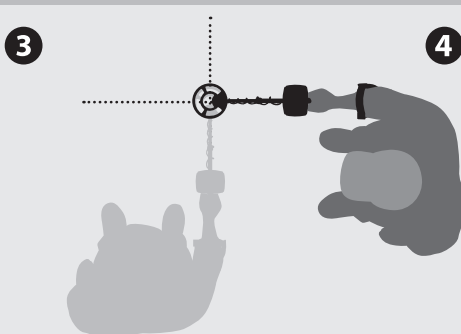

Pinpoint Sizing

After activating Pinpoint Sizing the Sensitivity is held at a constant level. This feature can be used in two ways:

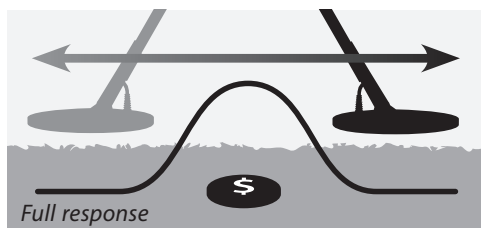

Activating Pinpoint Sizing while the coil is away from the target, then probing the perimeter of the target, will help identify the shape and size of the target. As the coil approaches the target the detector will give a response. Move the coil away from the target and approach the target from a different angle. Repeat the process until the size and shape of the target is determined. This can be very useful when trying to find valuable targets in amongst unwanted targets, such as pipes or fence wire.



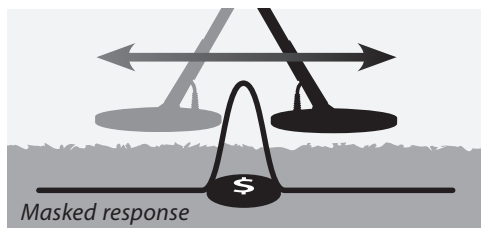

Activating Pinpoint Sizing while the coil is near the target will allow the target response to be narrowed by masking part of the target response. This is a similar effect to Pinpoint Auto, which reduces the sensitivity with each sweep, but you now manually control the masking of the target response. It is important to remember that activating Pinpoint Sizing whilst directly over the target may completely mask the target.



To toggle between Pinpoint Auto and Pinpoint Sizing modes:

- 1 Press **Pinpoint**  to go into Pinpoint mode
- 2 Press and hold **Pinpoint**  for approx. 3 seconds
- 3 The Pinpoint ring will flash 4 times and **PS** will be displayed for 2 seconds
- 4 The unit is now in Pinpoint Sizing mode. Start Pinpointing or press **Pinpoint**  to return to normal detecting. The next time you need to Pinpoint a target the unit will still be in Pinpoint Sizing mode and will give a double beep to indicate that you are in Pinpoint Sizing.

To return to the default Pinpoint Auto mode follow the same process:

- 1 Press **Pinpoint**  to go into Pinpoint mode
- 2 Press and hold **Pinpoint**  for approx. 3 seconds
- 3 The Pinpoint ring will flash 4 times and **PA** will be displayed for 2 seconds

! Do not initiate Pinpoint Sizing while over the centre of the target or the whole target may be masked.

! The X-TERRA 705 updates the Target ID and Depth whilst Pinpointing in Coin & Treasure Mode.

! In Pinpoint, Tracking Ground Balance is automatically disabled and re-enabled upon exiting Pinpoint.

The X-TERRA 705 operates in two display states – Detection and Settings.

Detection (display state)

 In Coin & Treasure Mode, the Target ID, discrimination segments and depth automatically translate target signals. The last detected Target ID stays on the display until another is detected. If the detector passes over a target that it rejects, the display will return to a detection screen represented by two dashes.

 In Prospecting Mode, the numeric identification and the Iron Mask Discrimination Scale are used to indicate the Iron Mask Level. Detections are indicated by sound only.

Settings (display state)

The X-TERRA 705 has a range of settings that should be adjusted to ensure optimum performance in different environments. These settings are accessed from the menu, or with shortcuts.

1 To access the menu settings, press **Menu/Select**  to repeatedly scroll through the adjustable settings.

2 To exit the menu press **Pinpoint/Detect** .

 The last detected Target ID will disappear and the depth icons will flash in sequence until a new Target ID is detected.

 The Iron Mask Discrimination level will return.

The X-TERRA 705 has three categories of settings; Mode Specific, General and Mode Dependent.

Mode Specific Settings

The Mode Specific Settings are used, and also saved, for one mode only.

 – Discrimination Pattern

– Target Tones

– Target ID Stability

 – Iron Mask Level

– Threshold Tone

General Settings

The General Settings do not change when toggling between Coin & Treasure Mode and Prospecting Mode.

– Noise Cancel channel

Mode Dependent Settings

The Mode Dependent Settings are saved separately for each mode. The detector automatically saves the settings of the previous mode when a new detect mode is selected or when the detector is turned off.

– Sensitivity

– Threshold for the speaker

– Threshold for the headphones

– Volume for the speaker

– Volume for the headphones

– Ground Balance

– Tracking Ground Balance

– Ground Balance (Beach)

Detection

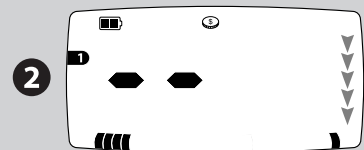
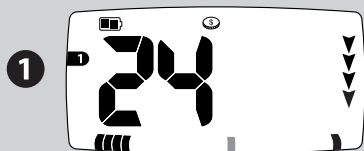

Settings

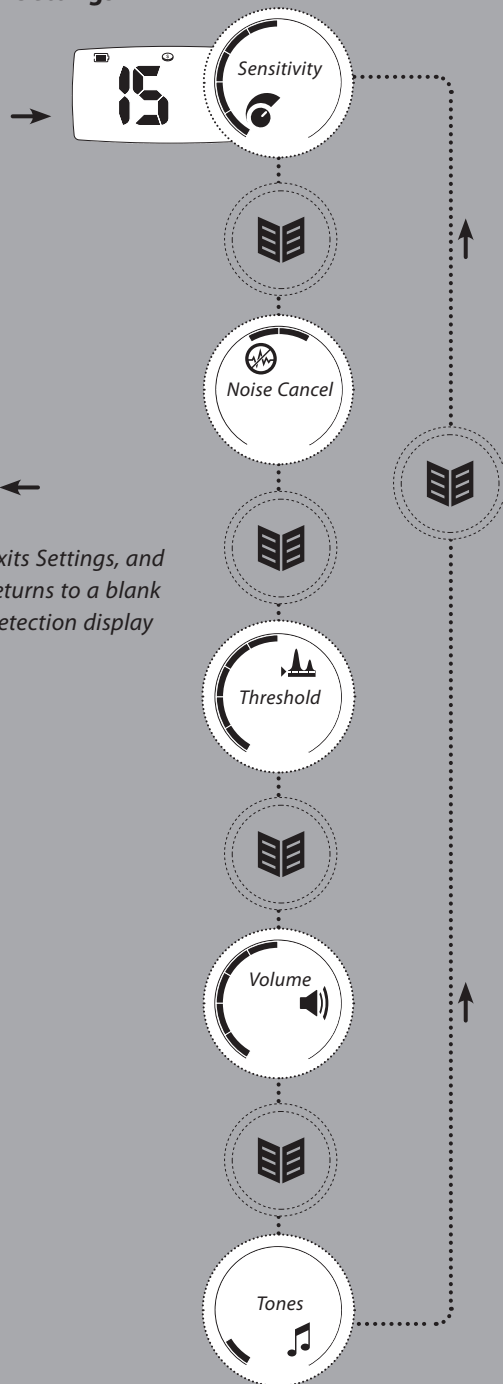

! *Ground Balance can only be accessed via the **Ground Balance**  button.*

! *Sensitivity has a range of 1–30. Threshold has a range of –5 to 25. Volume has a range of 0–30. Each segment on the menu scale represents three numbers of the Numeric ID.*

Ground balance has a range of 0–90. Each segment on the menu scale represents nine numbers of the Numeric ID.

The X-TERRA 705 is highly sensitive and has a wide Sensitivity adjustment range. It is important to set the correct Sensitivity level for your detecting conditions.

Sensitivity is the detector's level of response to a target and its environment. Real targets are indicated by distinct beeps and should stop if the coil is held stationary. Interference or false targets are interpreted as crackling or popping sounds and generally continue when the coil is held stationary.



Tiny ferrous junk targets might be detected when the Sensitivity is set to a high level. The detector will also be affected by minerals in certain soils and signals from electrical appliances.

Some experimentation with the Sensitivity scale may be required for different areas. For beginners, start with a low setting and increase it progressively.

Decreasing the Sensitivity of the X-TERRA 705 may stabilise the detector, reducing false signals and interference, and assisting in differentiating between signals caused by soil mineralisation and those of metal targets.

Always choose the highest stable Sensitivity setting to ensure optimum performance. Do this by holding the coil stationary; increase the Sensitivity until the detector becomes unstable; then reduce the Sensitivity by one or two settings until it is stable.

For beach detecting, a setting below 15 may be required. In high trash areas, such as modern parks, a setting below 9 may be required, especially when searching for shallow coins.

- 1** Press **Menu/Select**  and choose **Sensitivity** .
- 2** Use the **+** and **-** buttons to adjust the Sensitivity level.
- 3** Press **Pinpoint/Detect**  to return to detection.

! *The highest Sensitivity settings, 22-30, should be used only in the quietest, most stable conditions.*

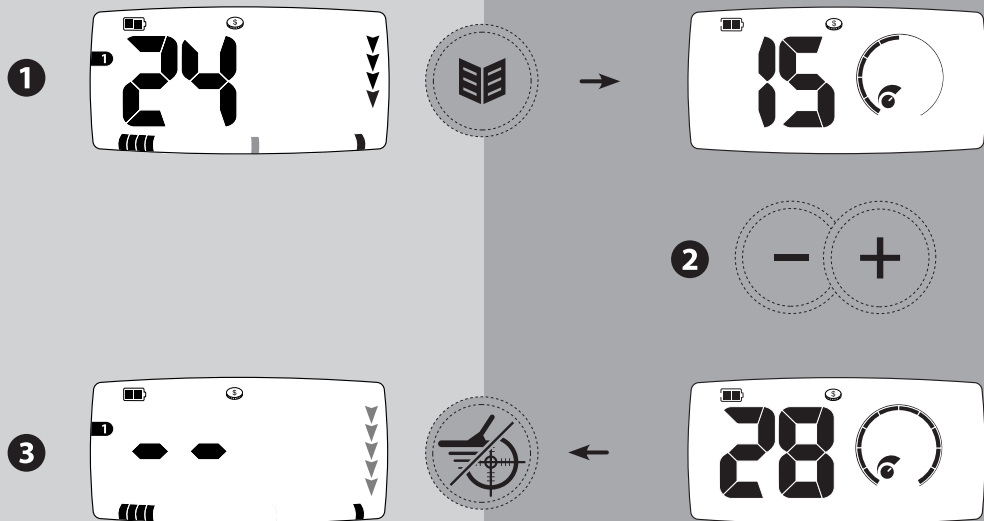

Recommended Sensitivity Settings

<i>Difficult ground or noisy conditions</i>	1–8
<i>Park with trash</i>	9
<i>New user</i>	12
<i>Salt water beach</i>	15
<i>Coin & Treasure Mode (Default)</i>	16
<i>Park with no trash</i>	20
<i>Prospecting Mode (Default)</i>	22
<i>Experienced user</i>	23–30

The detector may become noisy or erratic due to electrical interference from powerlines, electrical equipment or other detectors operating close by. This interference is interpreted as a crackling or popping noise.

Noise Cancel allows you to change the noise cancel channel so that you experience less interference. Five channels are available, represented by the numbers -2, -1, 0, 1, 2, and are also indicated on the menu scale.



It is best to choose a channel with the coil in the detection (horizontal) position because interference received in a vertical position may be different from the interference received in the horizontal position.

The coil should be held in the air and away from large targets when changing Noise Cancel channels.

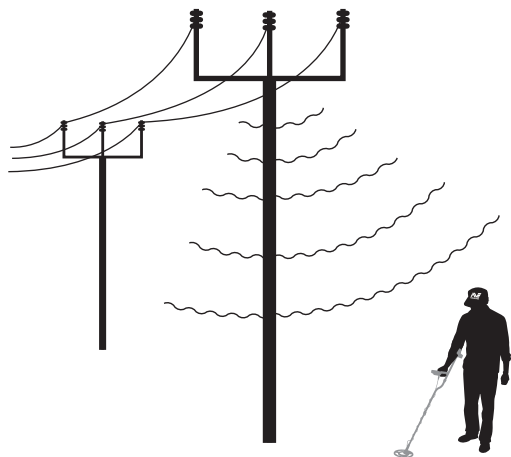



! *There is no loss in depth or sensitivity if the Noise Cancel channel is changed.*



Manual

- 1 Press **Menu/Select**  and choose **Noise Cancel** .
- 2 Use the **+** and **-** buttons to select the quietest Noise Cancel channel.
- 3 Press **Pinpoint/Detect**  to return to detection.

Auto

- 1 Press **Menu/Select**  and choose **Noise Cancel** .
- 2 Press **Mode**  to activate Automatic Noise Cancel. The letters **AU** will appear and the menu scale segments will be animated as a progress bar. Keep the detector still while this is occurring. After 15 seconds, the detector will automatically select a Noise Cancel channel.
- 3 Press **Pinpoint/Detect**  to return to detection.

! *Auto Noise Cancel will always choose the channel with the least amount of noise. This may change each time Auto is used.*

! *During Auto Noise Cancel, all button presses are ignored.*

Manual

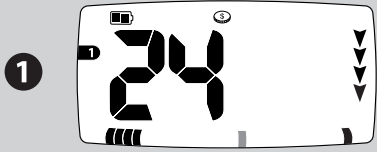

2



Auto

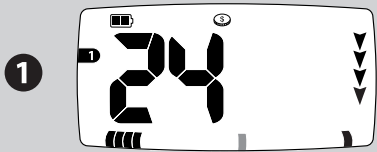

2

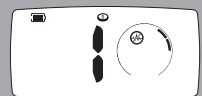
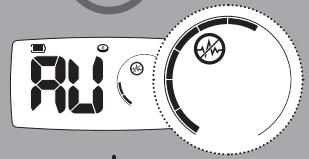

Threshold is the constant background sound produced by the detector to help distinguish between desirable and undesirable targets.

When a rejected target is detected, the Threshold sound 'blanks' (becomes silent) to indicate that a rejected target is underneath the coil.

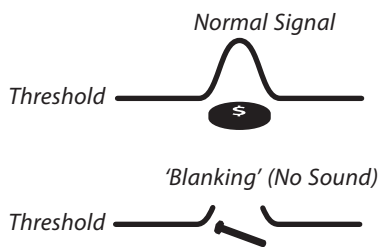



Speaker/Headphone Threshold

The X-TERRA 705 is able to save separate settings for both the speaker Threshold and headphones Threshold, switching from one to the other automatically as the headphones are connected (*Accessories*, p. 52).

When the headphones are unplugged, all changes to the Threshold setting are applied to the speaker Threshold. When the headphones are plugged in, the headphones icon will be displayed and all changes to the Threshold setting are applied to the headphones Threshold.

! The tone of the Threshold can be adjusted in Prospecting Mode only (*Threshold Tone*, p. 38).

The Threshold volume should be set to the preferred level. It is important to note that small surface objects, as well as large deep objects, will produce very small changes in the Threshold sound. It is therefore important to set the Threshold control correctly to ensure that these targets are heard. Try experimenting with known targets to assist in setting this control.

- 1 Press **Menu/Select**  and choose **Threshold** .
- 2 Use the **+** and **-** buttons to select a suitable Threshold level.
- 3 Press **Pinpoint/Detect**  to return to detection.

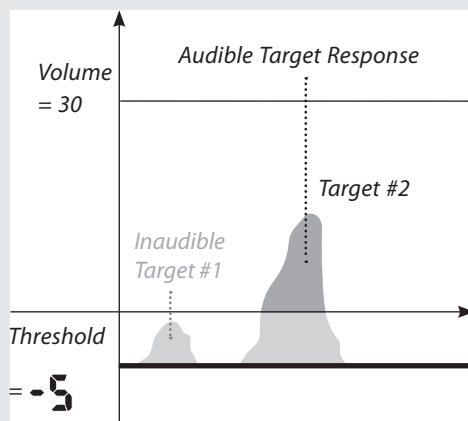

If the Threshold is set to a negative value, small target signals will not produce a signal big enough to go above the Threshold of audibility.

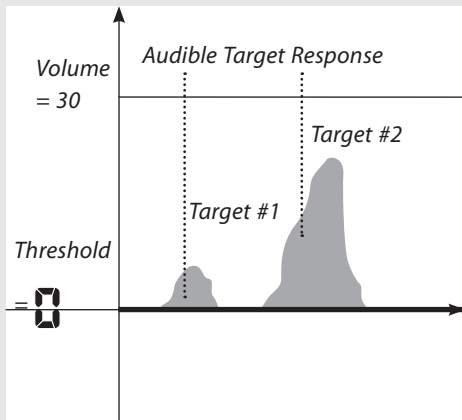
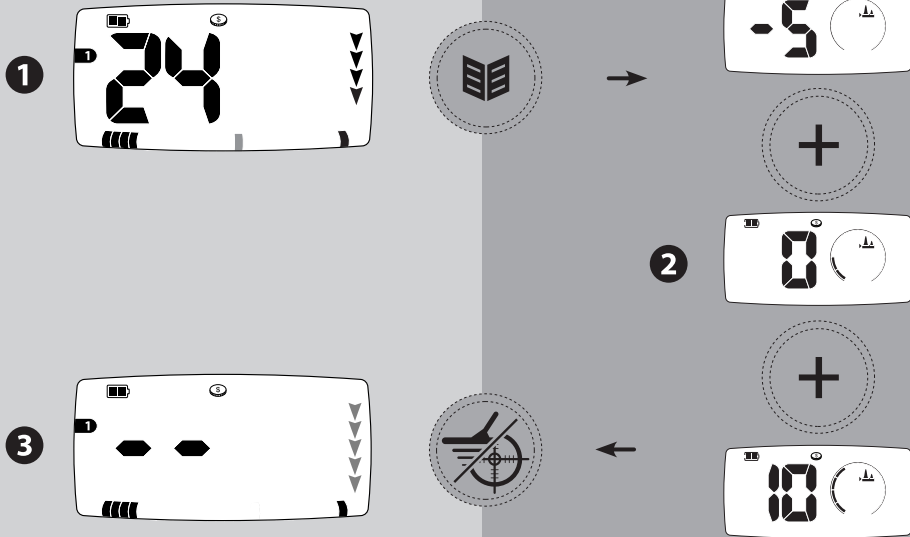

If the Threshold is set to 0, the Threshold audio/sound is disabled and detector will produce target signals sounds only.

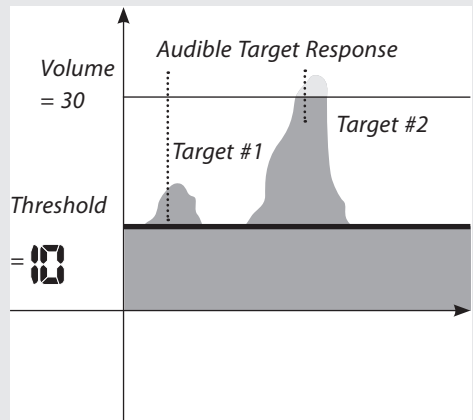

If the Threshold is set to a positive value, high enough for you to hear the faint hum, the detector will produce target signals and a Threshold sound. It is recommended that you set a Threshold that is still very low; a high Threshold can mask small target signals.

When Threshold and Volume settings are used together, there is greater control over target audio response.

Volume is the level of sound emitted by the detector when a target is detected. The Volume control limits the maximum volume of target signals.

The sound produced by a distant target starts softly. As you get closer, the volume level increases rapidly until it reaches the maximum level that has been set.

The sound produced by the detector in Pinpoint or Ground Balance will vary in volume and pitch depending on the signal strength (from a target or ground mineralisation). This volume range is proportional to the maximum volume setting.



Speaker/Headphone Volume

The X-TERRA 705 is able to save separate settings for both the speaker volume and headphones volume, switching from one to the other automatically as the headphones are connected (*Accessories, p. 52*).

Set the speaker volume without headphones connected. Set the headphones volume with the headphones connected. Use the simple detecting exercise (*p. 16*) with different targets to confirm both the speaker and headphones volume settings.

When the detector battery is low (indicated by the low battery icon) the speaker volume limit will be automatically reduced. This saves battery power and extends detecting time.

You may choose to override this and increase the volume limit, but you then risk the detector shutting down sooner.

- 1** Press **Menu/Select**  and choose **Volume** .
- 2** Use the **+** and **-** buttons to adjust the Volume limit.
- 3** Press **Pinpoint/Detect**  to return to detection.

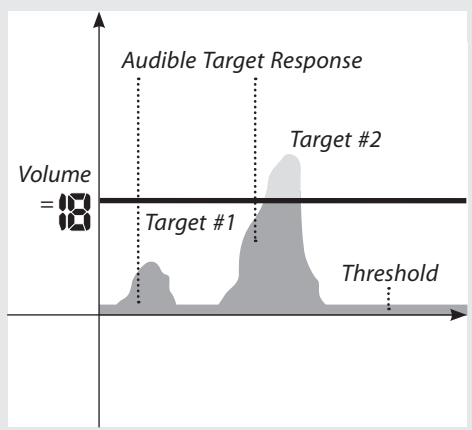
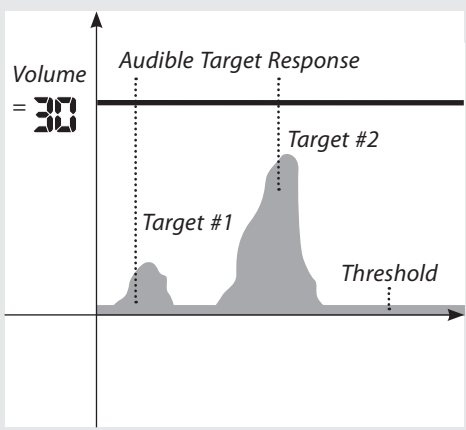
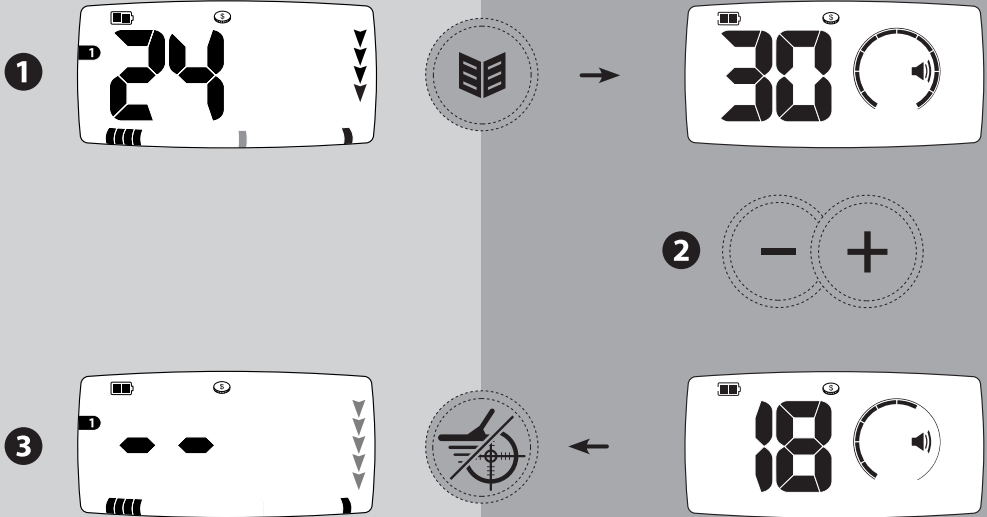

! *When using headphones, it is recommended that the volume be set so that a loud target signal will not damage your hearing.*



When Volume and Threshold settings are used together, there is greater control over target audio response.

Target Tones

The number of Target Tones may be selected from the Tones menu. There are five different options listed in the table below.

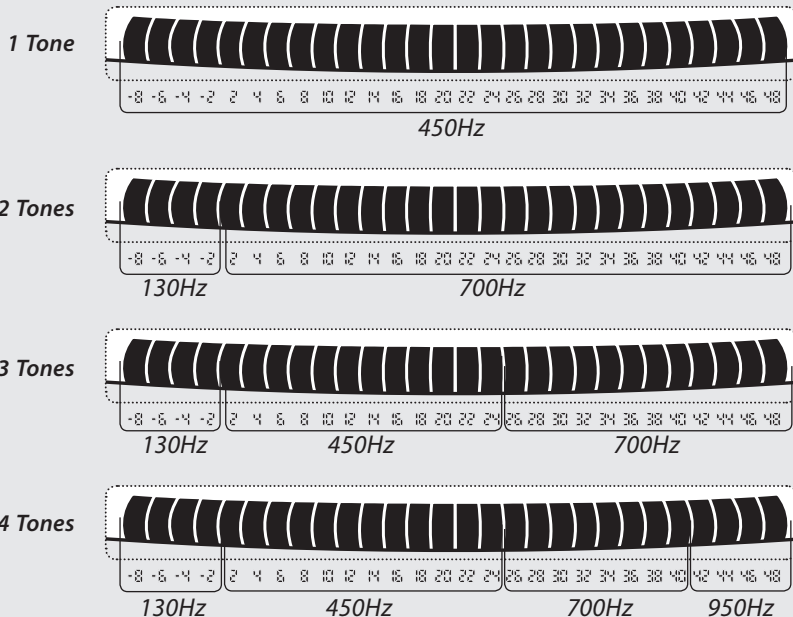

- 1 Press **Menu/Select**  and choose **Tones** .
- 2 Use the **+** and **-** to select either 1, 2, 3, 4, or Multiple Target Tones (99).
- 3 Press **Pinpoint/Detect**  to return to detection.



Multiple Tones Pitch can vary during target detection in the 130Hz-950Hz range. The pitch depends on the Target ID that is determined during the detection.

Threshold Tone

In Prospecting Mode, the pitch of the Threshold Tone can be adjusted using the Tones menu. This is a personal preference and will vary depending on the type of headphones being used. The Threshold pitch ranges from 140Hz to 1010Hz.

- 1 Press **Menu/Select**  and choose **Tones** .
- 2 Use the **+** and **-** buttons to select a Threshold Tone (1-30).
- 3 Press **Pinpoint/Detect**  to return to detection.

! The frequency/pitch of the Threshold tone for the Coin & Treasure Mode is set to 230Hz and cannot be changed.

Adjusting Target Tones in Coin & Treasure Mode

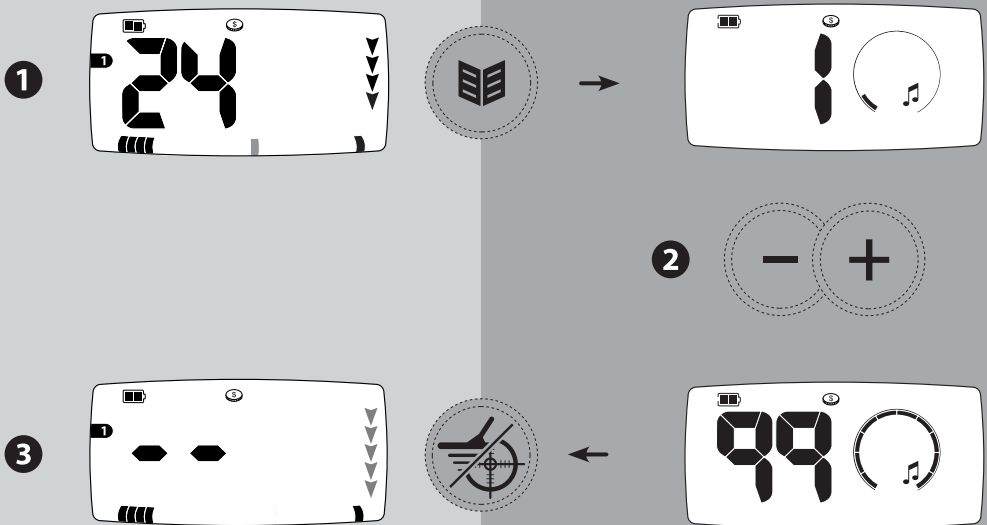

Adjusting Threshold Tone in Prospecting Mode

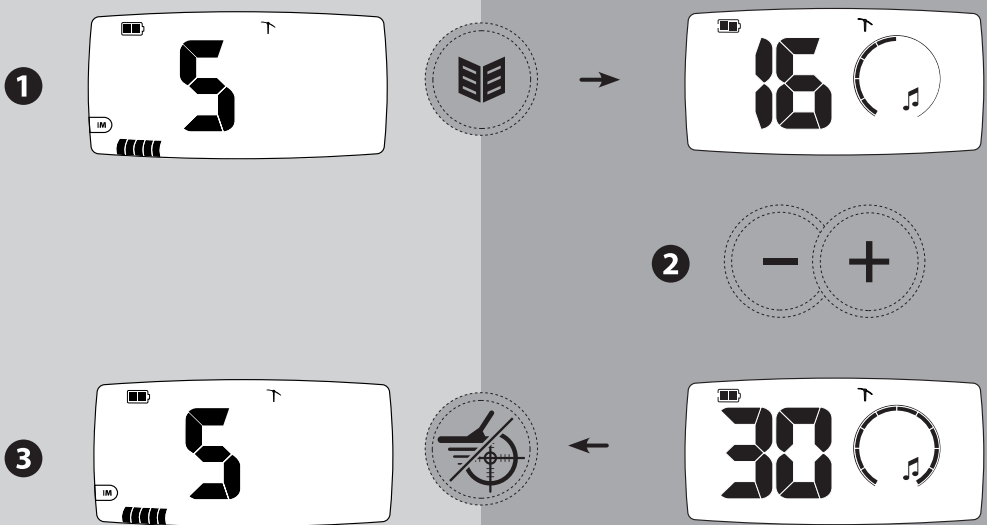

The X-TERRA 705 is capable of operating in two different types of grounds, magnetic (e.g. inland parks and goldfields) and conductive (wet areas of salt water beaches). Ground mineralisation may cause false target signals in all environments. Ground Balancing the detector reduces these ground signals and enables good targets to be displayed and/or heard correctly.

Ground Balance (Normal)

Ground Balance (Normal) is suitable for most neutral soils and dry sand use and is operating when the beach icon is off.

 An unbalanced detector in Coin & Treasure Mode will blank continuously (if a pattern rejecting -8 is used) or detect -8 continuously (if a pattern accepting -8 is used).

 An unbalanced detector in Prospecting Mode will produce a continuous 'warbling' sound that differs from the sharper sound of a real target signal.

Ground Balance (Beach)

Ground Balance (Beach) is suitable for salt water beach use and is operating when the beach icon is on.



In Ground Balance (Beach) the X-TERRA 705 can Ground Balance any combination of magnetic and conductive soil (e.g. a mixture of sand, soil and salt water). However, ferrous and some low conductivity targets can be balanced out. For this reason in Ground Balance (Beach), Tracking should be used only when targets are far apart.

 *Ground Balancing in highly mineralised soils is far easier when using a Double D coil.*

Adjusting Ground Balance



The Ground Balance setting can be adjusted in three ways; automatically, manually or with Tracking.

Auto Ground Balance will generally give a good Ground Balance setting. This may be further adjusted manually, using the + and - buttons.

- 1 Press **Ground Balance** .
- 2 Adjust Ground Balance with Auto, Manual or Track (p. 42).
- 3 Press **Pinpoint/Detect**  or **Ground Balance** to return to detection.

 *When detecting on the beach, adjusting Ground Balance may not give significant improvements. Try adjusting Sensitivity and altering Patterns for best results.*

Activating Ground Balance (Beach)

- 1 Press **Ground Balance** .
- 2 Press and hold **Ground Balance** for three seconds. The beach umbrella icon will appear to indicate that Ground Balance (Beach) is activated.
- 3 To de-activate Ground Balance (Beach), press and hold **Ground Balance** for three seconds. The beach umbrella icon will disappear indicating that Ground Balance (Beach) is de-activated.
- 4 Press **Pinpoint/Detect**  or **Ground Balance** to return to detection.

 *Ground Balance settings affect both normal detection and Pinpoint operation.*

Adjusting Ground Balance

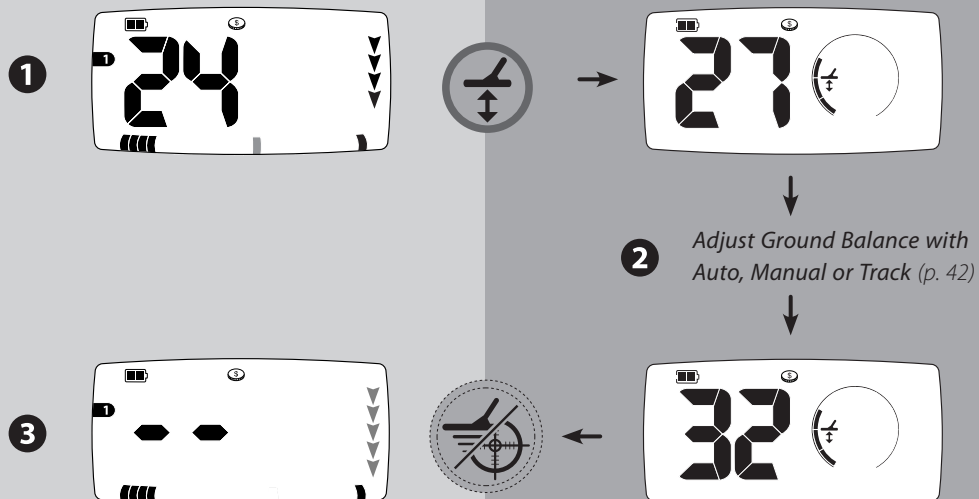

Ground Balance (Beach)

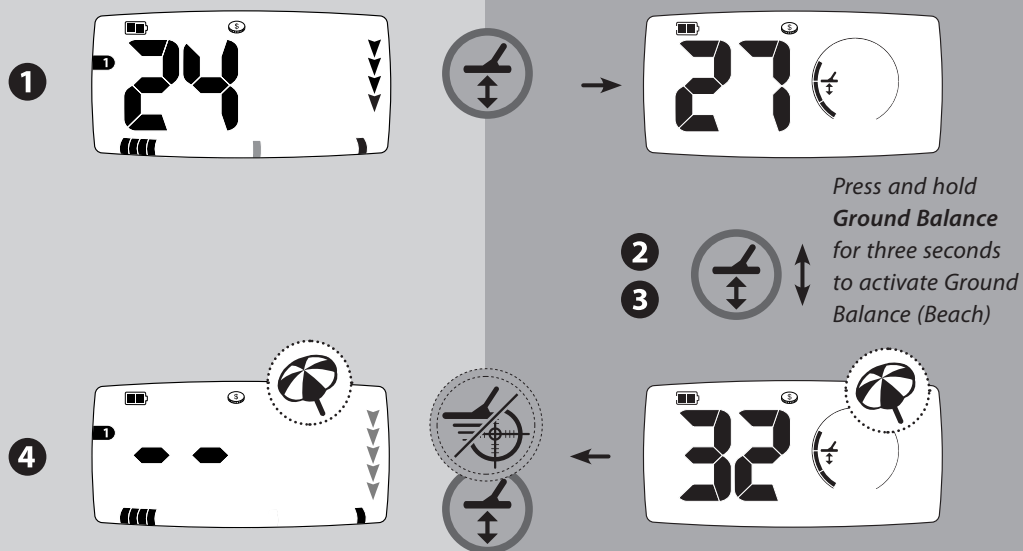

Auto

- 1 Using the detector in All Metal, find a clear area of ground without any targets.
- 2 Hold the coil parallel and 4" (10 cm) above the ground. Select **Ground Balance** . A constant hum known as the Ground Balance tone will sound when the coil is held steady.

- 3 Press **Mode**  to activate Automatic Ground Balance, and begin to continuously lower and raise the coil over the ground. The letters **AU** will appear and the menu scale segments will be animated as a progress bar. The detector will automatically select a Ground Balance setting. Approximately 2–10 seconds, depending on soil conditions.

Manual

- 1 Using the detector in All Metal, find a clear area of ground without any targets.
- 2 Hold the coil parallel and 4" (10 cm) above the ground. Select **Ground Balance** .
- 3 Continuously lower and raise the coil over the ground and listen to the Ground Balance tone. Try to lower the coil as close to the ground as possible without touching it.

! *If the detector is in Tracking, and then the Ground Balance is manually adjusted, Tracking is automatically de-activated.*



- 4 If the tone is low, increase the Ground Balance setting using **+**, if the tone is high, decrease the setting using **-**. Aim for a minimum volume and the transition between a low tone and a high tone. The menu scale and Numeric ID will indicate the chosen setting.
- 7 If the detector makes a sound when the coil goes down, increase the Ground Balance setting using **+**. If the detector makes a sound when the coil goes up, decrease the Ground Balance setting using **-**. Aim for a minimum volume variation. The menu scale and numeric ID will indicate the chosen setting.

Tracking

Tracking Ground Balance follows the changes in ground conditions and constantly adjusts the Ground Balance while detecting.

As Tracking Ground Balance constantly updates the Ground Balance automatically, repeated passes over a target may result in the detector balancing to the target instead of the ground, diminishing the target signal.

It is recommended that Tracking Ground Balance is toggled off when a target is detected.

- 1 Press **Tracking**  to activate Tracking Ground Balance.
- 2 While Tracking Ground Balance is activated, the Tracking icon and current Ground Balance value will be displayed. The setting scale will also become animated.
- 3 To de-activate, press **Tracking**  again.

! *Once Tracking is pressed, the detector will track very fast for the first three seconds. The detector will then continue to Track at a slower speed until Tracking is de-activated.*

Auto

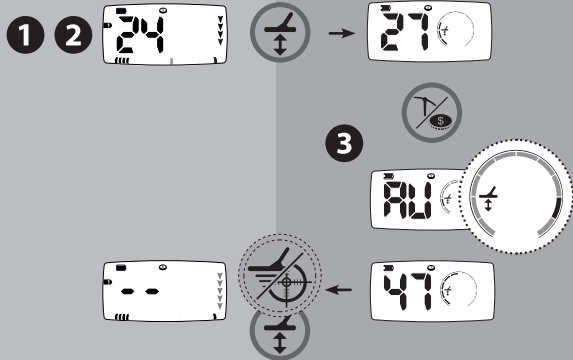

Manual

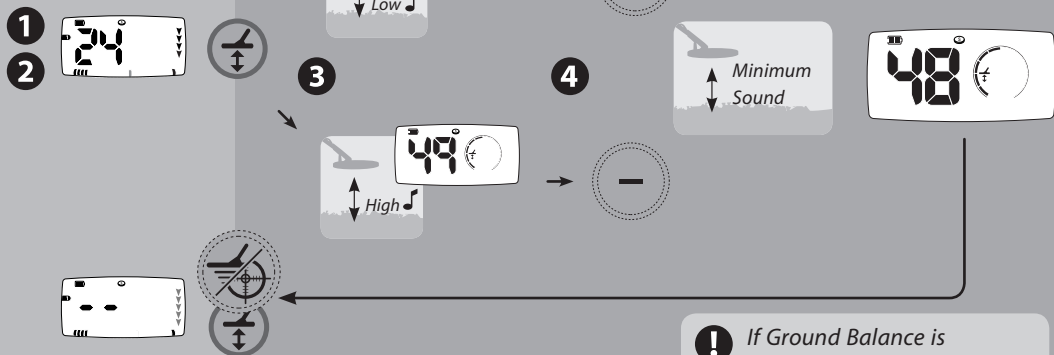

! If Ground Balance is between two numbers, select the lowest number.

Tracking

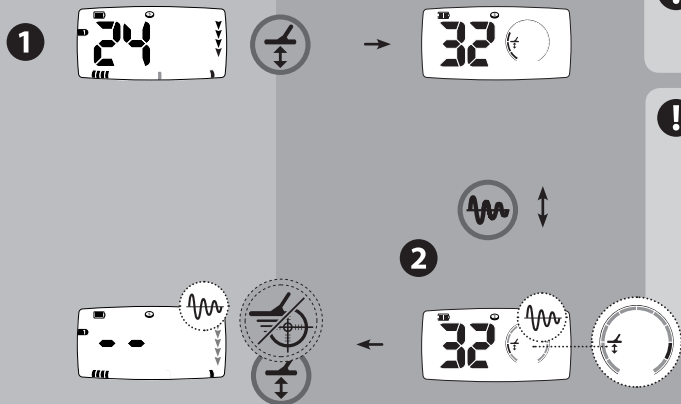

! Tracking can be activated in either the detection or the Ground Balance screen.

! When Pinpoint is activated, Tracking Ground Balance is automatically disabled. When Pinpoint is deactivated, Tracking Ground Balance is automatically re-enabled.



This setting is recommended for experienced users.



Tracking GB Offset allows you to set the Tracking Ground Balance slightly positive or negative allowing a performance advantage under certain conditions.

For example, this can be useful in mineralised ground with hot rocks. The ground can be balanced and then the Tracking GB Offset adjusted to help reduce the effects of the hot rocks. When detecting on the dry-wet transition at the beach, dry sand will require one Ground Balance setting and wet sand another. You can use Tracking GB Offset to compromise between the dry and wet sand.

A negative Tracking GB Offset (-1 to -15) may slightly improve sensitivity in very mild soils. A positive Tracking GB Offset (+1 to +15) may slightly improve target ID accuracy.

To set your Tracking GB Offset:

- 1 Select **Ground Balance** 
- 2 Press **Accept/Reject**  to enter Tracking GB Offset. The Ground Balance icon will continuously flash and the offset number is displayed via the digits and menu scale.
- 3 Press the **+** or **-** buttons to adjust.
- 4 Press **Accept/Reject**  to save your setting and return to Ground Balance.

Press **Ground Balance**  or **Pinpoint/Detect**  to save the Tracking GB Offset and return to the main detection screen

The GB number displayed in the GB screen when you are in Tracking mode is the neutral GB plus the Offset setting. For example, if neutral ground balance is 45 and the Offset setting is +5, then the displayed number is 50.

Some experimentation with the Tracking GB Offset may be required while detecting so that you may find your optimum setting.

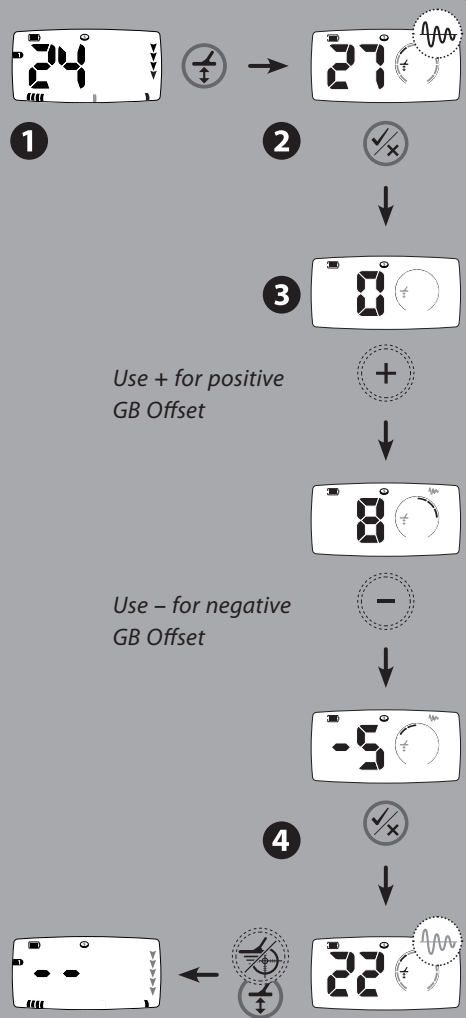

! Remember, your Tracking Ground Balance Offset will only function when you are using the Ground Balance Tracking mode.

! When the Tracking GB Offset is not neutral (0) the Tracking icon will flash when you are in the Ground Balance menu.

The X-TERRA 705 is capable of using different types of AA batteries:

1.5 V Alkaline

1.5 V Carbon

1.5 V Lithium (non-rechargeable)

1.2 V NiMH (rechargeable)

1.2 V NiCad (rechargeable)

When the detector battery is low, the speaker volume will be reduced; saving battery power and extending detecting time. The headphone volume is not affected.

! Rechargeable Lithium Ion batteries will give a combined voltage above 8 V and therefore cannot be used with the X-TERRA 705.

! The use of headphones will extend battery life.

The graph below is a representation of how 1.5 V and 1.2 V batteries may discharge over time. How the detector is used will affect how long the batteries last for.

Overvoltage

If the battery voltage is too high (above 8V), the battery icon will flash and the detector will shut down.



Full

2 black segments inside the outline.



Half

1 black segment inside the outline.



Low

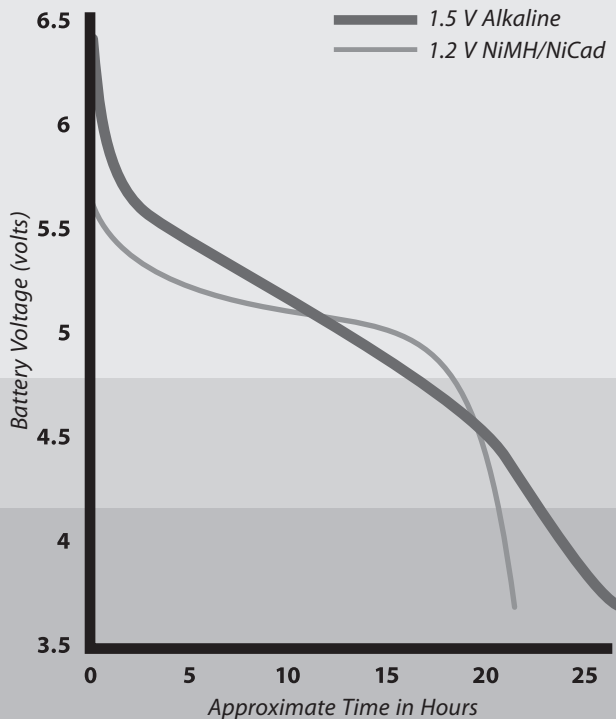

The icon will begin to flash for a period of time and there will be audio announcements every 60 seconds before the detector finally shuts down.



Menu Factory Preset

Mode Specific, General and Mode Dependent settings are all saved when the X-TERRA 705 is switched off (p. 12).

To return to all of the preset menu values:

- 1 Turn the detector off.
- 2 While pressing and holding **Menu/Select**  turn the detector back on by pressing **Power**  once.
- 3 During the start-up sequence release **Menu/Select** .

After the start-up sequence, the Factory Preset message (**FP**), will appear for three seconds to indicate that all settings have been returned to the preset values.



 *Factory Preset does not erase Discrimination Patterns.*

 *The Mode Factory Preset does not erase General Settings and Discrimination Patterns.*

Patterns Factory Preset

-  Custom patterns are saved when the X-TERRA 705 is switched off.



To erase custom patterns and return to preset patterns:

- 1 Turn the detector off.
- 2 While pressing and holding **Patterns** , turn the detector back on by pressing **Power**  once.
- 3 During the start-up sequence release **Patterns** .

After the start-up sequence, the Patterns Erased message (**PE**) will appear for three seconds, indicating that the custom patterns have been erased and returned to the preset patterns.

Mode Factory Preset

The X-TERRA 705 allows the user to reset settings for the current detect mode only.

- 1 Select the detect mode which needs to be reset.
- 2 Turn the detector off.
- 3 While pressing and holding **Mode**  turn the detector back on by pressing **Power** .
- 4 During the start-up sequence release **Mode** .

After the start-up sequence the Mode Factory Preset message (**FP**) will appear for three seconds to indicate that all settings have been returned to the preset values.

Coin & Treasure Mode Factory Presets

<i>Discrimination Pattern</i> 	1
<i>Sensitivity</i>	16
<i>Ground Balance</i>	(Fixed) 27
<i>Noise Cancel Channel</i>	0
<i>Threshold (Speaker)</i>	12
<i>Threshold (Headphones)</i>	10
<i>Volume (Speaker)</i>	25
<i>Volume (Headphones)</i>	20
<i>Target Tones</i> 	4

Prospecting Mode Factory Presets

<i>Iron Mask</i> 	5
<i>Sensitivity</i>	22
<i>Ground Balance</i>	(Track)
<i>Noise Cancel Channel</i>	0
<i>Threshold (Speaker)</i>	10
<i>Threshold (Headphones)</i>	8
<i>Volume (Speaker)</i>	25
<i>Volume (Headphones)</i>	20
<i>Threshold Tone</i> 	22

Menu Factory Preset

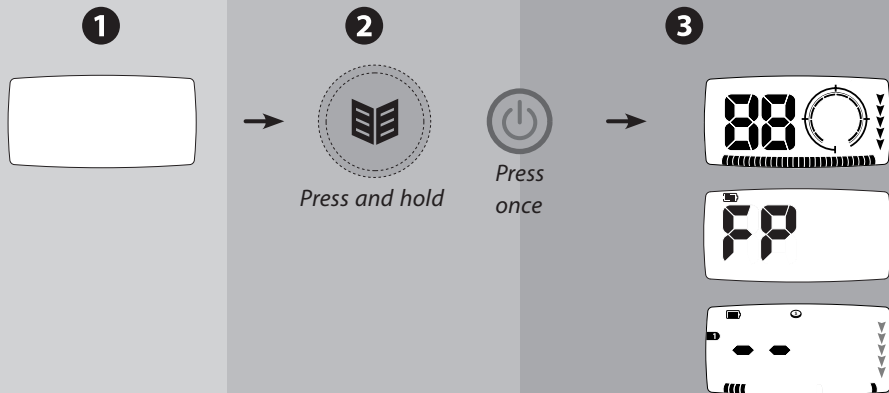

Mode Factory Preset

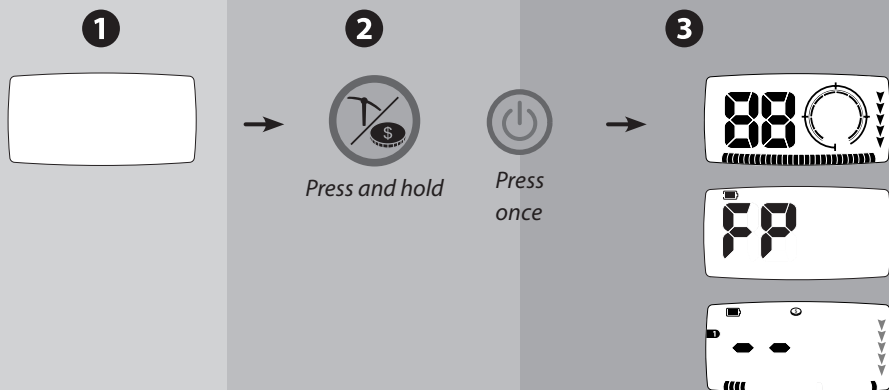

Patterns Factory Preset

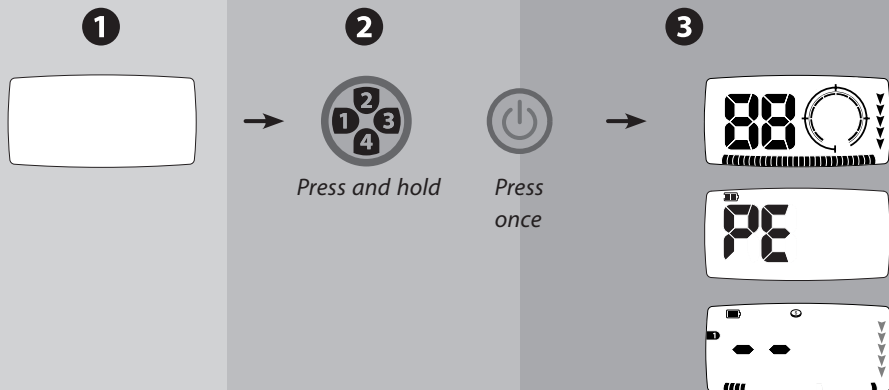

The X-TERRA 705 is capable of operating at three different transmission frequencies set by VFLEX compatible coils.

Concentric Standard (7.5kHz)

This frequency is most suitable for general detecting for most ground conditions. These coils have a label with the letter **M** on them.

Concentric Low (3kHz)

This frequency is more suited to searching for larger, deeper targets, higher-conductivity coins (eg. most US coins) and has improved ferrous rejection. These coils have a label with the letter **L** on them.





Concentric High (18.75kHz)

This frequency is more suited to searching for smaller shallow targets, gold nuggets and low conductivity targets (eg. hammered coins, fine jewellery). These coils have a label with the letter **H** on them.

Double D (7.5kHz and 18.75kHz)

The Double D coil allows the detector to ground balance more effectively. It is the ideal coil for detecting gold nuggets in heavily mineralised areas or beaches with black sand concentrates.

To view the type of coil:

- 1 Press **Menu/Select**  to enter the settings screen.
- 2 Press and hold **Accept/Reject**  to view the coil identification screen.
- 3 Release **Accept/Reject**  to return to settings.
- 4 Press **Pinpoint/Detect**  to return to detection.

! The X-TERRA 705 operates with Concentric (c) and Double D (d) coils.

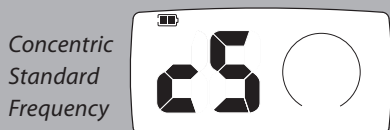
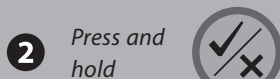
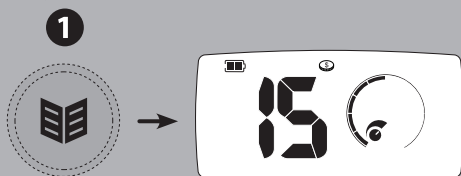

Coil Unplugged

The coil is not connected to the detector.



Coil Error

The coil is not communicating with the control box.



Coil Incompatible

The coil is communicating with the control box but the detector is not recognising it.

Turn the detector off before connecting a standard coil.

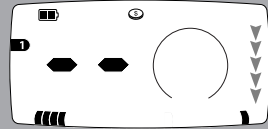

Overload

The detector has received a signal that is too strong for it to interpret. The letters **OL** will appear until signal is no longer too large.

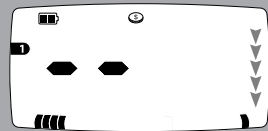

! Once all errors are resolved, the detector will begin operation with a blank detection screen.

Threshold

This is the background 'buzz' given by the detector to help distinguish between accepted and rejected targets.

Blanking

When a rejected target is detected, the Threshold sound 'blanks' (becomes silent) to indicate that a rejected target is underneath the coil.

Target Response

This is the sound given by the detector when a target is located and not rejected.

 In Coin & Treasure Mode, a target that is highly conductive (e.g. a large silver coin) generally causes a high tone beep and ferrous targets generally cause a low tone beep.

 In Prospecting Mode, a target signal will cause an abrupt change in the pitch and volume of the Threshold tone.

Pinpoint Response

When in Pinpoint, the detector emits a variable tone, that increases in tone and volume as the coil gets closer to the target.

Noise

A random, jittery sound indicates that the detector is picking up external interference. Sensitivity or Noise Cancel should be adjusted.

False Signals

Ground mineralisation can cause sounds that can be mistaken for target signals. False detections can be partial, random beeps (Coin & Treasure Mode) or a continuous 'warbling' sound that differs from the sharper sound of a real target signal (Prospecting Mode).

Start Up Sequence

When the detector is turned on there is a short three note tune during its start-up sequence.

Positive Acknowledgement

The detector emits a short beep for every valid key press.

Negative Acknowledgement

The detector emits a low double beep to indicate an invalid keypress.

Completed

A three note tune indicates the completion of a function (e.g. Auto Noise Cancel channel calibration).

Patterns Erased / Factory Preset

A six note tune will announce when these settings are complete.

Error

A six note tune will sound to indicate a detector error (*Error Messages, p. 49*).

Overload

If the coil is passed across a large shallow target or very highly mineralised ground, the detector might give a repeating buzzing sound. This indicates that the target signal is too strong for the detector to interpret.

Low Battery Signal

When the battery power becomes low, there will be a short announcement tune (descending tones) every 60 seconds.

Low Battery Shutdown

A long announcement tune (descending tones) will sound just before the detector shuts down.

A trowel, knife or small spade are good tools for recovering targets.

Once a target has been located, clear the surface of loose material and check again for a signal. If there is no signal then the target is amongst the surface material. In this case, search the surface material until the target is located. If the target is still in the ground, check again with Pinpoint.

When digging, the aim is to leave the area of ground exactly as you found it. Using a sharp tool, cut a neat portion of grass or soil and place it on a plastic sheet. This prevents the material being scattered around and allows the hole to be refilled quickly.

Check the hole for the target. If it is not in the hole, place the detector on the ground with the coil flat, pick up a handful of soil and pass it over the coil. Be sure not to wear rings, bracelets or a watch which will produce a signal. Repeat this procedure until the target is located.

Ensure that no other targets remain, then refill the hole. All soil and portions of grass on the plastic sheet should be returned to the hole as neatly as possible. Step lightly on the soil to compact it.

Leaving holes, or a scarred area, may result in action being taken to prevent the use of metal detectors. Please ensure that an area of ground is left as you found it. Remove all rubbish.



Ask for permission before searching on private property.

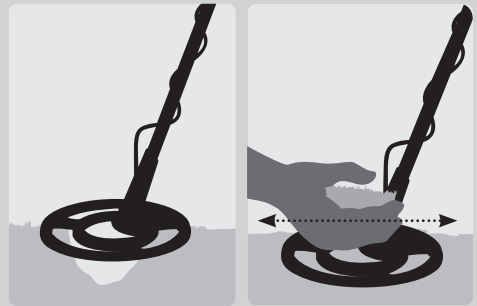
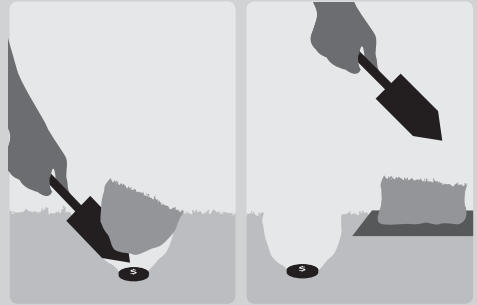

The use of **headphones** while detecting, has many advantages. They block out external noise such as wind and traffic, allowing you to listen more closely to target signals. Headphones also minimise disturbance to other people in the area and they extend battery life.

The X-TERRA 705 is able to save separate settings for both the speaker volume and headphone volume, switching from one to the other as soon as the headphones are connected.

(Threshold, p. 34)

(Volume, p. 36)



! *Ensure that the headphone volume does not reach an extremely loud level. This may increase the risk of hearing damage.*

Connecting Headphones

Always use headphones with a 1/4" jack.

- 1** Open the rubber headphone cover located on the left hand side of the control box.
- 2** Plug the headphone jack into the socket.
- 3** When the detector is turned on, the headphones icon will appear on the LCD to indicate that the headphones are connected.

! *When not using headphones, keep the rubber cover closed to protect the control box electronics from moisture and dust.*

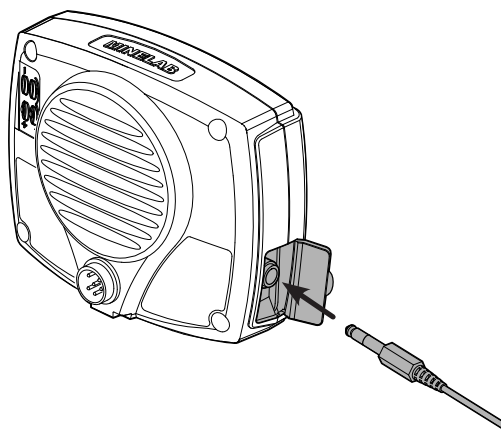

Short Shaft

A short shaft is available to decrease the length of the detector.

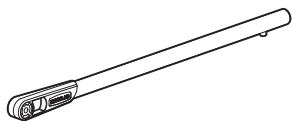

Environmental Cover

Protects the control box from environmental conditions such as rain and dirt.

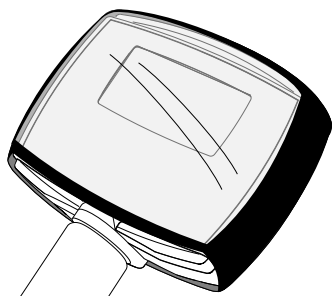

Skid Plate

A skid plate comes as standard with the detector. If it wears out from excessive sweeping along the ground, accessory skidplates are available for purchase.

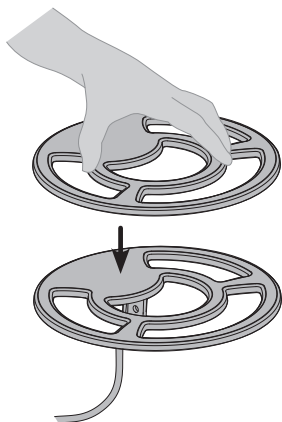

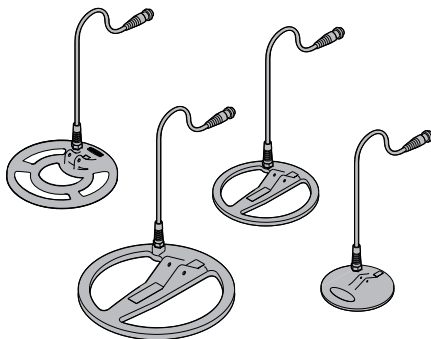

Accessory Coils

Are available in different types (Concentric and Double D), sizes and frequencies. These coils are suitable for different ground conditions and specific targets.



To attach an accessory coil:

- 1 Turn the detector off using **Power** .
- 2 Follow the steps of *Coil Cable Assembly* (p. 7) and *Connecting the Coil* (p. 5) in reverse order to disconnect the coil from the detector.
- 3 Repeat the same steps in the correct order to connect a different coil.
- 4 Turn the detector on using **Power** .



The X-TERRA 705 is a high quality electronic instrument, finely engineered and packaged in a durable housing. Taking proper care of your X-TERRA 705 is common sense.

- ! The storage temperature of the X-TERRA 705 is -4°F to 149°F (-20°C to $+65^{\circ}\text{C}$) and the operating temperature is 32°F to 113°F (0°C to 45°C). Do not leave the detector in excessive heat or cold for longer than necessary.
- ! The coil can be submerged in water up to 20" (0.5m), but the control box is not waterproof. Although it has been designed to be weather resistant, it is advisable to protect the control box in wet conditions. A protective control box cover is available (*Accessories, p. 52*).
- ! Never allow the detector to come into contact with gasoline or other petroleum-based liquids.
- ! Keep the detector clean and dry and avoid getting sand and grit into the shafts or fastenings (e.g. yoke, twistlocks). Do not use solvents to clean the detector. Use a damp cloth with mild soap detergent.
- ! Always remember to turn the detector off before changing coils.
- ! Coils from other models of Minelab detectors will not function with the X-TERRA 705 (*Accessories, p. 52*).
- ! Only VFLEX compatible coils will operate correctly with the X-TERRA detectors (*Coil Identification, p. 48*).
- ! The display window may be prone to scratching or damage if not treated with care. A protective control box cover is available (*Accessories, p. 52*).
- ! Ensure that the coil cable is in good condition and not subject to undue stress, particularly where it is connected to the coil.
- ! Old, flat, or faulty batteries can cause many problems with the detector, through electrolyte leakage. Take the batteries out if the detector will be unused for more than 1 week. Ensure that only good quality batteries are used and that they are replaced when the low battery signal sounds.
- ! Do not use rechargeable Lithium Ion batteries as their voltage is too high. Non-rechargeable Lithium batteries may be used.

Transmission	Single Frequency Sine Wave
Technology	VFLEX
Coil	Standard 9" Concentric 7.5 kHz
Visual Display	Transflective LCD with Backlight
Audio	Internal Speaker and Headphone Output
Search Mode	Motion Detector
Discrimination	Multi-Segment Accept/Reject/Iron Mask
Batteries (Not Included)	4 x AA Alkaline/Carbon/Lithium or NiMH/NiCad
Padded Armrest	4 Position Adjustable with Stand & Armrest
Length Extended	56" (1.42m)
Length Collapsed	48" (1.22m)
Weight (Excluding Batteries)	2.9lbs (1.3kg)
Optional Accessories	Headphones, Skidplates, Environmental Cover, Accessory Coils, Short Shaft
Model Features	
Coil Frequency Options	3 (Standard 7.5 kHz, Low 3kHz, High 18.75 kHz)
Detecting Modes	Coin & Treasure, Prospecting
Discrimination Patterns	4 + All Metal
Iron Mask Discrimination (Prospecting Mode)	0 to 20
All Metal Shortcut	✓
Discrimination Scale (Segments)	28
Ferrous	4
Nonferrous	24
Numeric Range (Target ID Numbers)	Steps of 2 (-8, -4, -2, 0, 2, 4, 6, 8, 10, 12, 14, 16, 18, 20, 22, 24, 26, 28, 30, 32, 34, 36, 38, 40, 42, 44, 46, 48)
Depth Indication Icons	5
Sensitivity Adjustment	Manual, 1 to 30
Noise Cancel Channels	Auto or 5 Manual (-2, -1, 0, 1, 2)
Ground Balance Adjustment	Manual 1-90, Auto, Tracking, Beach
Tracking Ground Balance Offset	-15 to 15
Pinpoint (Audio & Visual)	2 Modes (Auto and Sizing)
Volume Adjustment	0 to 30
Threshold Adjustment	-5 to 25
Audio Tones for Target IDs	1, 2, 3, 4, Multiple
Low Battery Audio Alarm	✓
User Interface Keys	11 + Power
LCD Icons	82
Shaft Colour	Black

In the interests of product improvement, Minelab reserves the right to make changes without notice.

Owners Name

Address

Telephone Day () Home ()

Fax ()

Email

Todays Date

Detector / Model

Serial Number

Purchased From

Purchase Date

Faulty Part(s)

.....

DESCRIPTION OF FAULT

Please explain how we can replicate the problem in order to fix your detector.

.....
.....
.....
.....
.....
.....
.....
.....
.....
.....
.....
.....
.....
.....
.....

cut out or photocopy



CONGRATULATIONS ON PURCHASING YOUR X-TERRA 705!

Metal detecting is a fascinating and rewarding activity enjoyed by people all over the world. By getting to know your X-TERRA 705 you can become one of the many who find valuable coins, relics, gold and jewellery on a regular basis.

The X-TERRA 705 is a high-precision instrument incorporating Minelab's proven single frequency technology, VFLEX.

VFLEX processes a pure single frequency, ensuring that you can enjoy the hobby at all times, confident that you are using a highly-tuned and dependable detector. In other words, a SERIOUS detector.

This manual is designed to help both the beginner and expert treasure hunter get the best performance out of the X-TERRA 705.

QUICK START

- 1 Turn on (p. 12)
- 2 Choose a detecting mode (p. 12)
 - Coin & Treasure Mode (p. 18)
 - Prospecting Mode (p. 19)
- 3 Choose a Discrimination Pattern (pp. 22–24) Set the Iron Mask Level (pp. 22–24)
- 4 Set Noise Cancel (Auto or Manual) (pp. 32–33)
- 5 Set Ground Balance (Auto, Manual or Track) (pp. 40–43)
- 6 Begin detecting!

These quick start instructions allow you to begin detecting straight away and find important reference information for setting up your X-TERRA 705.

Minelab encourages all users to read the entire manual to ensure a complete understanding of all the features and functions that your X-TERRA 705 offers.

Minelab is always interested in your opinions. If you have any questions or comments regarding your X-TERRA 705 or any other Minelab product, please feel free to contact us directly or via your local Authorised Minelab dealer.

For further product information and detecting tips, refer to:

www.minelab.com



The World Leader in Metal Sensing Technology

From our origins in 1985, Minelab have specialised in advanced electronic technologies. Our competitive advantage was created almost immediately with a highly competent and innovative Research and Development team, inspired by the genius of Mr Bruce Candy.

This commitment to innovation has enabled us to successfully market feature packed Consumer coin and treasure detectors enjoyed by hobbyists worldwide as well as high quality gold detectors used by both professionals and amateurs. Minelab's advanced technology is also incorporated in detection equipment designed for military and humanitarian de-mining projects throughout the world.

Today Minelab has manufacturing, distribution and customer service operations in Australia, Europe and the United States, and is an ISO 9001 Quality Endorsed Company. ISO 9001 is a worldwide quality standard certification that ensures the highest level of product quality for our customers.

Working for a Cleaner, Greener Future

For Consumers within the European Union: Do not dispose of this equipment in general household waste.

The crossed wheeled bin symbol on this equipment indicates this unit should not be disposed of in general household waste, but recycled in compliance with local government regulations and environmental requirements.

Please dispose of this equipment via a recycling service or centre, or by returning the unit to the respective Minelab outlet as appropriate for your unit. This will enable the equipment to be disposed of in an environmentally safe manner.

Disposal of unwanted electronic equipment in land filled waste may contribute to adverse long term environmental effect due to the leaching of contaminating and toxic substances contained within some electronic equipment.

THIS DEVICE COMPLIES WITH PART 15 OF THE FCC RULES

Operation is subject to the following two conditions: (1) this device may not cause harmful interference, and (2) this device must accept any interference received, including interference that may cause undesired operation.

Disclaimer:

The Minelab metal detector discussed in this instruction manual has been expressly designed and manufactured as a quality hobbyist metal detector and is recommended for use in coin, treasure and general metal detection in nonhazardous environments. This metal detector has not been designed for use as a mine detector or as a live munitions detection tool.

© 2016 Minelab Electronics Pty Ltd.

This document contains proprietary information which is protected by copyright. Apart from any use as permitted under the Copyright Act 1968, no part may be reproduced by any process without written permission from Minelab Electronics Pty Ltd, 2 Second Ave, Mawson Lakes, SA 5095, Australia.

WARNING: This document contains Minelab Electronics Pty Ltd rights, technical data or restricted rights data, or both. Patents and trademarks apply. Serious Detecting and Minelab are all trademarks of Minelab Electronics Pty Ltd.

US Patent No: 7432715.
AU Patent No: 2005276953.

Please note:

Since there may be a variety of options available for this detector, equipment may vary according to the Model or items ordered with your detector. Certain descriptions and illustrations may also differ (in this manual) from the exact Model that you purchased. In addition, Minelab reserves the right to respond to ongoing technical progress by introducing changes in design, equipment and technical features at any time.



Part Number: 4901-0073-4

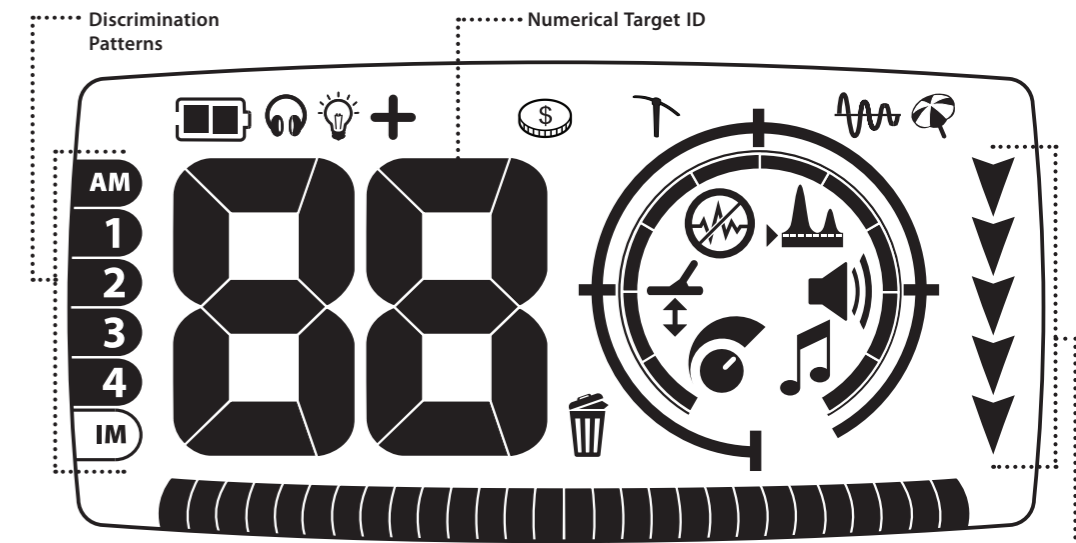

- Battery**
Indicates remaining power.
- Headphones**
Indicates headphones are connected.
- Backlight**
Indicates that the Backlight is on.
- Target Stability**
Indicates that Target Stability is on.
- Reject Identification**
Appears when you reject a discrimination segment.

- Discrimination Scale**
- Coin & Treasure**
Indicates that you are in the Coin & Treasure Detect Mode.
- Prospecting**
Indicates that you are in the Prospecting Detect Mode.
- Track**
Indicates that Tracking Ground Balance is active.
- Beach**
Indicates that Ground Balance Beach is active.
- Sensitivity**
Indicates that you are in the Sensitivity menu.

- Depth Gauge**
- Ground Balance**
Indicates that you are in the Ground Balance menu.
- Noise Cancel**
Indicates that you are in the Noise Cancel menu.
- Threshold**
Indicates that you are in the Threshold menu.
- Volume**
Indicates that you are in the Volume menu.
- Tones**
Indicates that you are in the Tones menu.

- ## QUICK START
- 1 Turn on (p. 12)
 - 2 Choose a detecting mode (p. 12)
 - Coin & Treasure Mode (p. 18)
 - Prospecting Mode (p. 19)
 - 3 Choose a Discrimination Pattern (pp. 22–24) Set the Iron Mask Level (pp. 22–24)
 - 4 Set Noise Cancel (Auto or Manual) (pp. 32–33)
 - 5 Set Ground Balance (Auto, Manual or Track) (pp. 40–43)
 - 6 Begin detecting!